



5550

IGNITRON

SIZE A

5550

DATA**General:**

Peak Voltage Drop (Approx.) 12 volts
 Cooling:
 Type Air, or Water-Cooled Clamp
 Clamp Width (Approx.) 1-3/4"
 Clamp Location See Outline Drawing
 Mounting Position Vertical, Flexible Lead Up
 Max. Rigid Length (Approx.) 10"
 Maximum Diameter 2-3/4"

AC WELDER-CONTROL SERVICE *

Ratings are for any voltage from 250 to 600 volts rms
at frequencies from 25 to 60 cycles

Maximum Ratings, Absolute Values:

	Air Cooled*	Water Cooled	
DEMAND	105 max.	300 max.	kva
CORRESPONDING AVERAGE ANODE CUR.	3 max.	12.1 max.	amp
AVERAGE ANODE CURRENT	5.6 max.	22.4 max.	amp
CORRESPONDING DEMAND	35 max.	100 max.	kva
TIME OF AVERAGING ANODE CURRENT:			
AT 500 VOLTS RMS	15.5 max.	11 max.	sec
AT 250 VOLTS RMS	31 max.	22 max.	sec
SURGE ANODE CURRENT	■	■	peak amp
PEAK POSITIVE IGNITOR VOLTAGE §	900 max. 200 min.	900 max. 200 min.	volts
PEAK NEGATIVE IGNITOR VOLTAGE			5 max.
PEAK IGNITOR CURRENT §	100 max.	100 max.	amp
	30 min.	30 min.	amp
AVERAGE IGNITOR CURRENT** . .	1 max.	1 max.	amp
IGNITION TIME §	100 max.	100 max.	μsec
COOLING CLAMP TEMPERATURE . .	75 max.	50 max.	°C

* Mercury condensation in the anode-seal must be prevented by suitable heating devices.

• RMS demand-voltage, -current, and -kva are on the basis of full-cycle conduction (no phase delay) regardless of whether or not phase control is used. Use the 250-volt rating for voltages below 250 volts.

** Averaged over any 5-second interval.

■ Must be limited to 280% of maximum rms demand current.

§ Ignition will occur if either minimum peak positive potential is applied, or minimum peak ignitor current flows, for the rated maximum ignitor ignition time.

5550



5550

IGNITRON

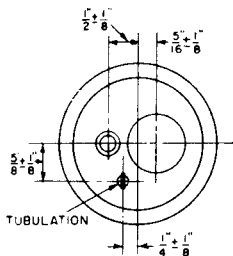
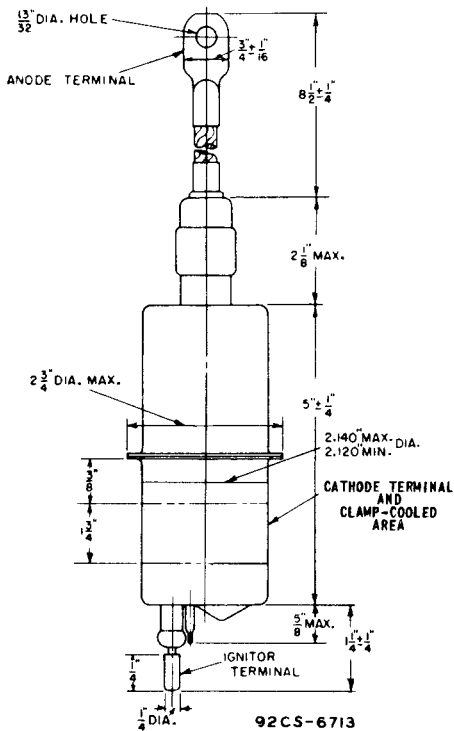

MAY 1, 1946

 TUBE DIVISION
 RADIO CORPORATION OF AMERICA, HARRISON, NEW JERSEY

CE-6713



5550

IGNITRON

5550

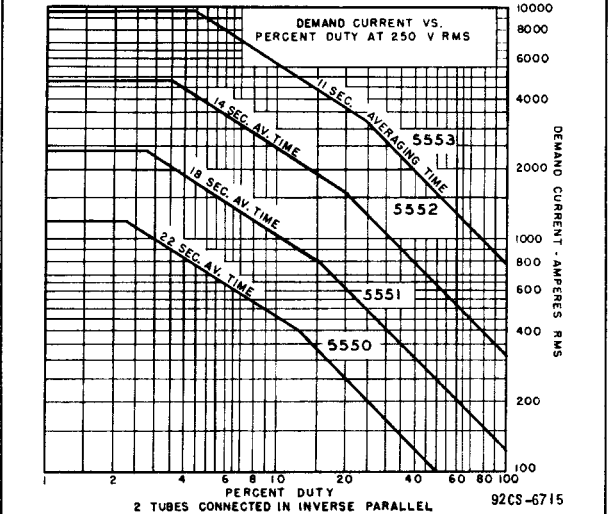
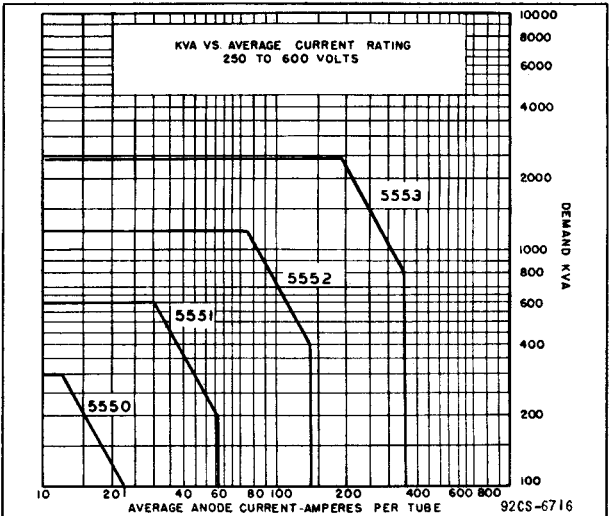

5550



5550

IGNITRON

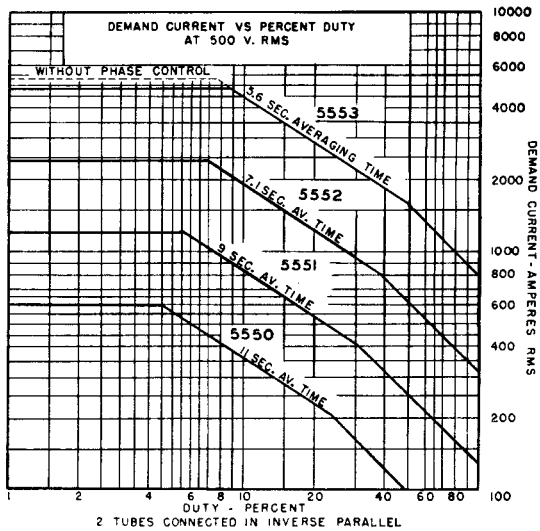

92CS-6714

Ignitron

SEALED, CLAMP-COOLED, MERCURY-PPOOL-CATHODE TYPE
For Resistance-Welding Control

GENERAL DATA

Electrical:

Cathode Excitation.	Cyclic
Cathode-Spot Starting	By Ignitor
Minimum Requirements for Cathode Excitation:	
Peak ignitor voltage required to fire	200 volts
Peak ignitor current required to fire	30 amp
Starting time at required voltage or current	100 μ sec
Tube Voltage Drop:	
At peak anode current of 1697 amperes	30 volts
At peak anode current of 70.4 amperes	12 volts

Mechanical:

Operating Position.	Vertical, flexible lead up
Maximum Overall Length (Including flexible lead).	17-5/8"
Maximum Diameter.	2-1/2"
Weight (Approx.).	1.5 lbs

Terminal Diagram (See *Dimensional Outline*):

P - Anode Terminal (Flexible lead)
 K - Cathode Terminal (Lower portion of shell)

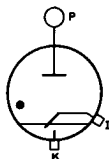

I - Ignitor Terminal (Adjacent to exhaust tube)

Cooling:

Type.	Air or water-cooled clamp
Clamp height (Approx.).	1-7/8"
Clamp location.	See <i>Dimensional Outline</i>

RESISTANCE-WELDING-CONTROL SERVICE*

Two Tubes in Inverse-Parallel Circuit

Maximum Ratings, Absolute-Maximum Values:

For frequencies from 25 to 60 cps

Ratings I-A and I-B Apply to Operation with a Clamp-Temperature Range of 10^o to 75^o C

RATING I-A

	Column 1 ^b	Column 2 ^b	
SUPPLY VOLTAGE (RMS).	250 max.	250 max.	volts
DEMAND POWER (During conduction).	50 max.	150 max.	kva

← Indicates a change.



	Column 1 ^b	Column 2 ^b	
DUTY ^{c,d}	10 max.	1.8 max.	%
ANODE CURRENT (Per tube):			
Peak	282 max.	846 max.	amp
Demand (RMS, during conduction) ^e	200 max.	600 max.	amp
Average (Averaged over any interval of 27.8 seconds maximum) ^e	9 max.	4.86 max.	amp
Fault, for duration of 0.15 second maximum	1680 max.	1680 max.	amp

RATING I-B

	Column 1 ^b	Column 2 ^b	
SUPPLY VOLTAGE (RMS)	600 max.	600 max.	volts
DEMAND POWER (During conduction) .	50 max.	150 max.	kva
DUTY ^{c,d}	24 max.	4.32 max.	%
ANODE CURRENT (Per tube):			
Peak	118 max.	354 max.	amp
Demand (RMS, during conduction) ^e	83 max.	250 max.	amp
Average (Averaged over any interval of 11.6 seconds maximum) ^e	9 max.	4.86 max.	amp
Fault, for duration of 0.15 second maximum	700 max.	700 max.	amp

Ratings II-A and II-B Apply to Operation with
a Clamp-Temperature Range of 10° to 50° C

RATING II-A

	Column 1 ^b	Column 2 ^b	
SUPPLY VOLTAGE (RMS)	250 max.	250 max.	volts
DEMAND POWER (During conduction) .	100 max.	300 max.	kva
DUTY ^{c,d}	12.4 max.	2.24 max.	%
ANODE CURRENT (Per tube):			
Peak	564 max.	1692 max.	amp
Demand (RMS, during conduction) ^e	400 max.	1200 max.	amp
Average (Averaged over any interval of 2.2 seconds maximum) ^e	22.4 max.	12.1 max.	amp
Fault, for duration of 0.15 second maximum	3360 max.	3360 max.	amp

RATING II-B

	Column 1 ^b	Column 2 ^b	
SUPPLY VOLTAGE (RMS)	600 max.	600 max.	volts
DEMAND POWER (During conduction) .	100 max.	300 max.	kva
DUTY ^{c,d}	30 max.	5.4 max.	%



ANODE CURRENT (Per tube):			
Peak	236 max.	708 max.	amp
Demand (RMS, during conduction) [•]	167 max.	500 max.	amp
Average (Averaged over any interval of 9.2 seconds maximum) [•]	22.4 max.	12.1 max.	amp
Fault, for duration of 0.15 second maximum.	1400 max.	1400 max.	amp

RESISTANCE-WELDING CAPACITOR-DISCHARGE SERVICE

Maximum Ratings, Absolute-Maximum Values:

RATING I

CLAMP TEMPERATURE	70 max.	40 max.	°C
NUMBER OF DISCHARGES PER SECOND.	60 max.	60 max.	
PEAK ANODE VOLTAGE:			
Forward	3000 max.	3000 max.	volts
Inverse	3000 max.	3000 max.	volts
ANODE CURRENT:			
Peak	500 max.	500 max.	amp
Average ^f	3 max.	15 max.	amp
Averaging time-interval ^f	3.3 max.	0.66 max.	sec
DURATION OF CATHODE-SPOT PER DISCHARGE			
	0.02 max.	0.02 max.	sec

RATING II

CLAMP TEMPERATURE	60 max.	40 max.	°C
NUMBER OF DISCHARGES PER SECOND.	60 max.	60 max.	
PEAK ANODE VOLTAGE:			
Forward	6000 max.	6000 max.	volts
Inverse	3000 max.	3000 max.	volts
ANODE CURRENT:			
Peak	500 max.	500 max.	amp
Average ^f	2.5 max.	8 max.	amp
Averaging time-interval ^f	4 max.	1.25 max.	sec
DURATION OF CATHODE-SPOT PER DISCHARGE			
	0.02 max.	0.02 max.	sec

IGNITOR

Maximum Ratings, Absolute-Maximum Values:

PEAK IGNITOR VOLTAGE:			
Positive.		900 max.	volts
Negative.		5 max.	volts
IGNITOR CURRENT:			
Peak.		100 max.	amp
Average (Averaged over any interval of 5 seconds maximum).		1 max.	amp
RMS		10 max.	amp

← Indicates a change.



- a RMS Voltage, current, and demand kva are on the basis of full-cycle conduction (no phase delay) regardless of whether or not phase control is used.
- b Column 1 represents operation at maximum average anode current; Column 2 represents operation at maximum demand power.
- c Defined as (cycles "on")/(cycles "on" + cycles "off") during the specified averaging time.
- d For supply voltages between 250 volts and 600 volts, duty is proportional to supply voltage. For supply voltages lower than 250 volts, the values for 250 volts apply.
- e For supply voltages between 250 volts and 600 volts, demand anode current and averaging time are each inversely proportional to supply voltage. For supply voltages lower than 250 volts, the values for 250 volts apply.
- f With the use of log-log paper, straight-line interpolation between tabulated points may be used to obtain average-anode-current and maximum-averaging-time ratings at clamp temperatures between the two tabulated values.



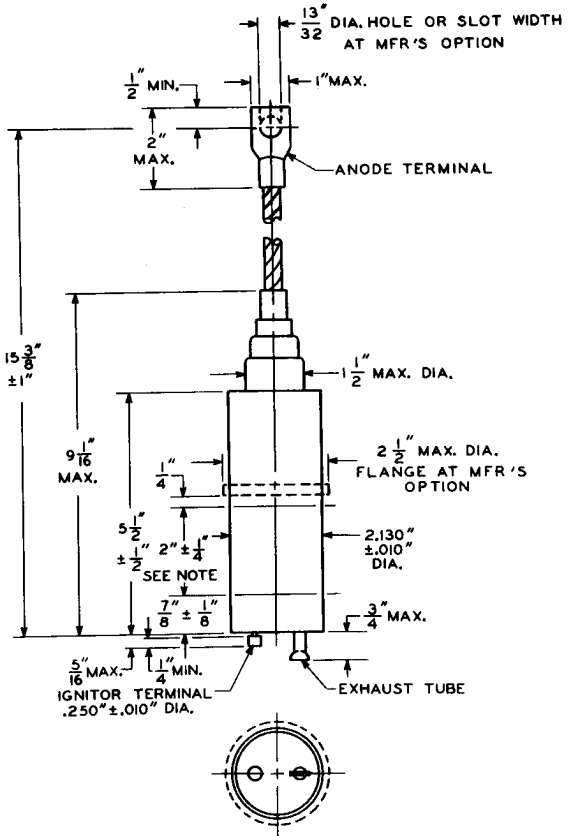

92CS-10843

NOTE: CATHODE TERMINAL AND CLAMP-COOLED AREA.



RATING CHART 1 Resistance-Welding-Control Service

TWO TUBES CONNECTED IN INVERSE PARALLEL
CLAMP TEMPERATURE (°C)=10 TO 50

CURVE	RMS ANODE SUPPLY VOLTS	MAXIMUM AVERAGING TIME—SECONDS
A	250	22
B	500	11
C	600	9.2

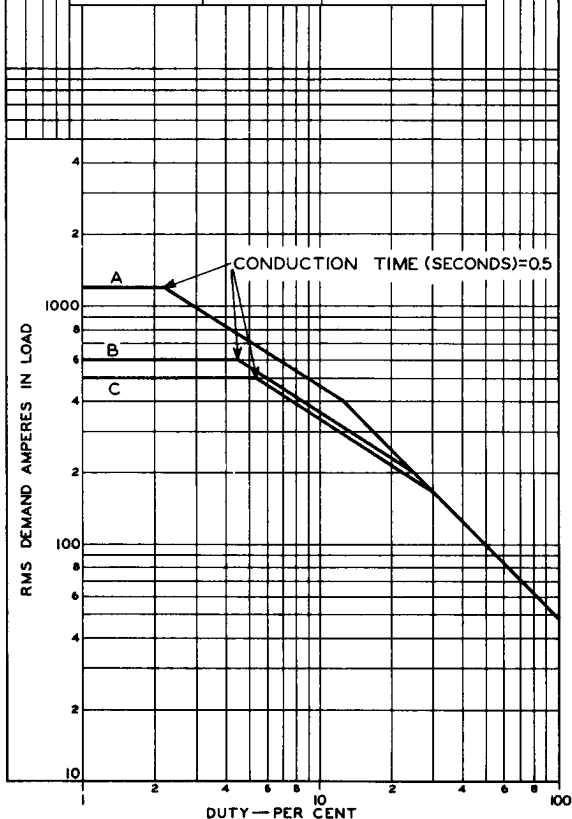

92CM-10840R1



RATING CHART 2

Resistance-Welding-Control Service

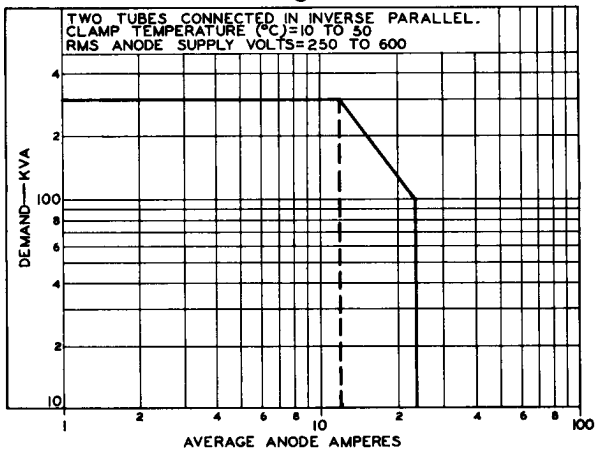

92CS-10842R1

