

Photomultiplier Tube

**10-STAGE, HEAD-ON, FLAT-FACEPLATE TYPE HAVING S-11 RESPONSE
1.24-INCH MINIMUM DIAMETER FLAT PHOTOCATHODE**

*For Detection and Measurement of Nuclear Radiation and Other
Low-Level Light Sources in Portable Scintillation Counters*

GENERAL

Spectral Response	S-11
Wavelength of Maximum Response	4400 ± 500 angstroms
Cathode, Semitransparent	Cs-Sb
Shape	Flat, Circular
Minimum area	1.2 sq in
Minimum diameter	1.24 in
Window	Lime Glass, Corning ^a No.0080, or equivalent
Shape	Plano-Plano
Index of refraction at 5893 angstroms	1.51
Dynodes	
Substrate	Ni
Secondary-emitting surface	Cs-Sb
Structure	Circular-Cage
Direct Interelectrode Capacitances (Approx.)	
Anode to dynode No.10	4.0 pF
Anode to all other electrodes	7.0 pF
Maximum Overall Length	4.57 in
Seated Length	3.88 ± 0.19 in
Maximum Diameter	1.56 in
Operating Position	Any
Weight (Approx.)	2.2 oz
Envelope	JEDEC T12
Base	Small-Shell Duodecal 12-Pin, (JEDEC No.B12-43), Non-hygroscopic
Socket	Eby ^b No.9058, or equivalent
Magnetic Shield	Millen ^c Part No.80802C, or equivalent ←

TERMINAL DIAGRAM (Bottom View)

Pin 1 - Dynode No.1
Pin 2 - Dynode No.3
Pin 3 - Dynode No.5
Pin 4 - Dynode No.7
Pin 5 - Dynode No.9
Pin 6 - Anode
Pin 7 - Dynode No.10
Pin 8 - Dynode No.8
Pin 9 - Dynode No.6
Pin 10 - Dynode No.4
Pin 11 - Dynode No.2
Pin 12 - Photocathode

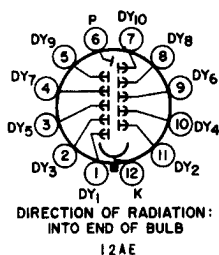

← Indicates a change.



ABSOLUTE-MAXIMUM RATINGS

DC Supply Voltage

Between anode and cathode	1250	V
Between dynode No.10 and anode.	250	V
Between consecutive dynodes	200	V
Between dynode No.1 and cathode	300	V
Average Anode Current ^d	0.75	mA
Ambient Temperature ^e	75	°C

CHARACTERISTICS RANGE VALUES

Under conditions with supply voltage (E) across voltage divider providing 1/6 of E between cathode and dynode No.1; 1/12 of E for each succeeding dynode stage; and 1/12 of E between dynode No.10 and anode.

With E = 1000 V (Except as noted)

	Min	Typ	Max	
Sensitivity				
Radiant ^f at 4400 angstroms	-	3.6×10^4	-	A/W
Cathode radiant ^g at 4400 angstroms.	-	0.036	-	A/W
Luminous ^h	10	45	300	A/lm
Cathode luminous:				
With tungsten light source ^j	3×10^{-5}	4.5×10^{-5}	-	A/lm
With blue light source ^k	2.8×10^{-8}	-	-	A
Quantum Efficiency at 4200 angstroms	-	10	-	A/lm
Current Amplification	-	1×10^6	-	
Equivalent Anode-Dark-Current Input^m.	{ -	2.3×10^{-10n}	2.5×10^{-9n}	1m
	{ -	2.8×10^{-13p}	3.1×10^{-12p}	W
Anode Dark Current^{m,n}.	-	4.5×10^{-9}	-	A
Dark Current to Any Electrode Except Anode (at 22°C).	-	-	7.5×10^{-7}	A
Equivalent Noise Input^q.	{ -	4×10^{-12}	1.7×10^{-11}	1m
	{ -	5×10^{-15p}	2.1×10^{-14p}	W
Anode-Pulse Rise Time^r.	-	2.8×10^{-9}	-	s
Electron-Transit Time^s.	-	3.3×10^{-8}	-	s

^a Made by Corning Glass Works, Corning, New York.

^b Made by Hugh H. Eby Company, 4701 Germantown Avenue, Philadelphia 44, Pennsylvania.

^c Made by James Millen Manufacturing Company, 150 Exchange Street, Walden 48, Massachusetts.

^d Averaged over any interval of 30 seconds maximum.

^e Tube operation at room temperature or below is recommended.

^f This value is calculated from the typical value for luminous sensitivity using a conversion factor of 804 lumens per watt.

^g This value is calculated from the typical value for cathode luminous sensitivity using a conversion factor of 804 lumens per watt.

→ Indicates a change.



- h Under the following conditions: The light source is a tungsten filament lamp having a lime-glass envelope. It is operated at a color temperature of 2870°K and a light input of 10 microlumens is used.
- j Under the following conditions: The light source is a tungsten filament lamp having a lime-glass envelope. It is operated at a color temperature of 2870°K . The value of light flux is 0.01 lumen and 167 volts are applied between cathode and all other electrodes connected as anode.
- k Under the following conditions: Light incident on the cathode is transmitted through a blue filter (Corning C.S. No.5-58, Glass Code No.5113 polished to 1/2 stock thickness—Manufactured by the Corning Glass Works, Corning, New York) from a tungsten-filament lamp operated at a color temperature of 2870°K . The value of light flux incident on the filter is 0.01 lumen and 167 volts are applied between cathode and all other electrodes connected as anode.
- m Measured at a tube temperature of 22°C . Dark current may be reduced by use of a refrigerant.
- n Measured with supply voltage (E) adjusted to give a luminous sensitivity of 20 amperes per lumen. Dark current is measured with no incident light on tube.
- p At 4400 angstroms. This value is calculated from the rating in lumen using a conversion factor of 804 lumens per watt.
- q Under the following conditions: Supply voltage (E) is as shown, 22°C tube temperature, external shield connected to cathode, bandwidth 1 Hz, tungsten-light source at a color temperature of 2870°K interrupted at a low audio-frequency to produce incident radiation pulses alternating between zero and the value stated. The "on" period of the pulse is equal to the "off" period.
- r Measured between 10 per cent and 90 per cent of maximum anode-pulse height. This anode-pulse rise time is primarily a function of transit time variation and is measured under conditions with the incident light fully illuminating the photocathode.
- s The electron transit time is the time interval between the arrival of a delta function light pulse at the entrance window of the tube and the time at which the output pulse at the anode terminal reaches peak amplitude. The transit time is measured under conditions with the incident light fully illuminating the photocathode.

Typical Effect of Magnetic Field on Anode Current

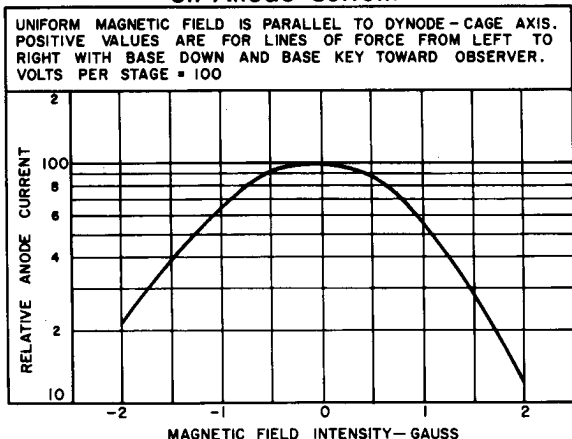

92LS-1469



TYPICAL VOLTAGE DIVIDER ARRANGEMENT

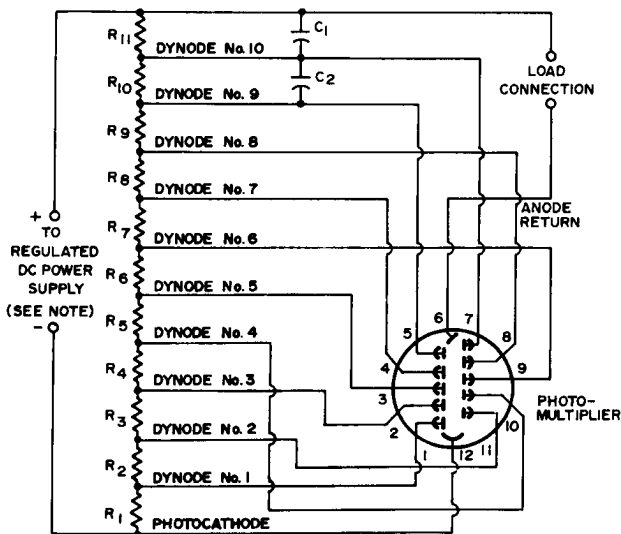

92LS-1506

Note: Adjustable between approximately 500 and 1250 volts dc.

C_1, C_2 : 0.01 μF , non-inductive type, 400 volts (dc working) — Values dependent on amplitude and duration of pulse.

R_1 : 91,000 ohms, 2 watts

R_2 through R_{11} : 47,000 ohms, 1 watt



DIMENSIONAL OUTLINE

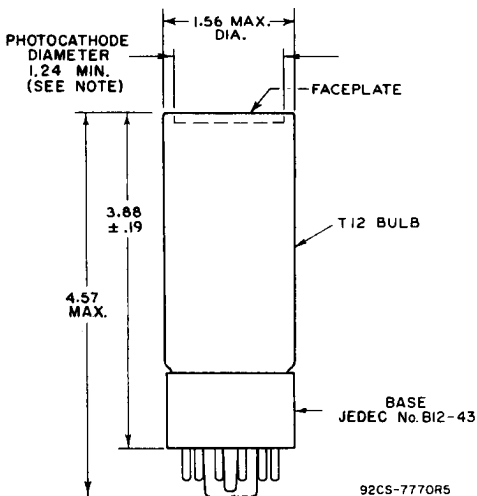

DIMENSIONS IN INCHES

Note: Deviation from flatness within the 1.24-inch diameter area will not exceed 0.010 inch from peak to valley. Center line of bulb will not deviate more than 2° in any direction from the perpendicular erected at the center of bottom of the base.



Typical Sensitivity and Current Amplification Characteristics

SUPPLY VOLTAGE (E) ACROSS VOLTAGE DIVIDER PROVIDING
 1/6 OF E BETWEEN CATHODE AND DYNODE No.1; 1/12
 OF E FOR EACH SUCCEEDING DYNODE STAGE; AND
 1/12 OF E BETWEEN DYNODE No.10 AND ANODE

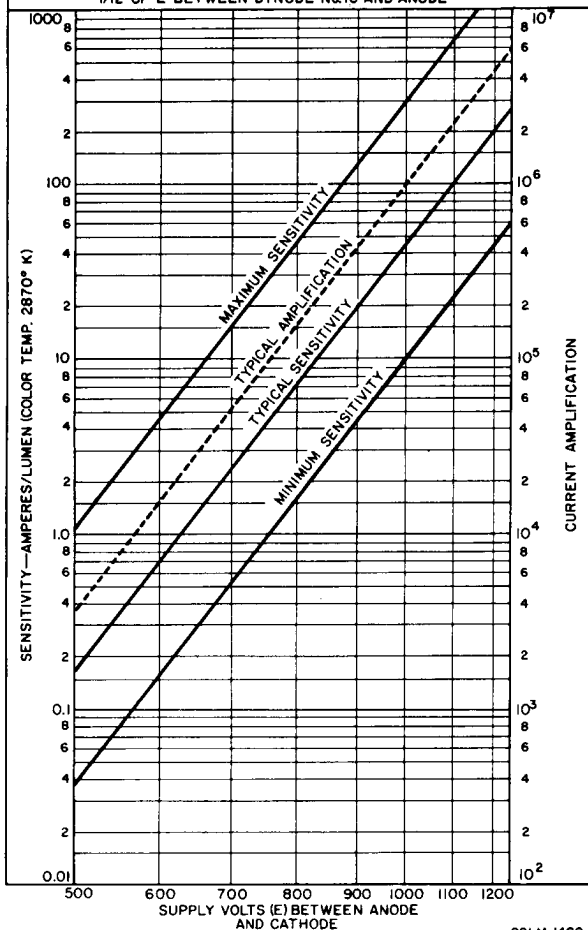

92LM-1480



Typical Anode Characteristics

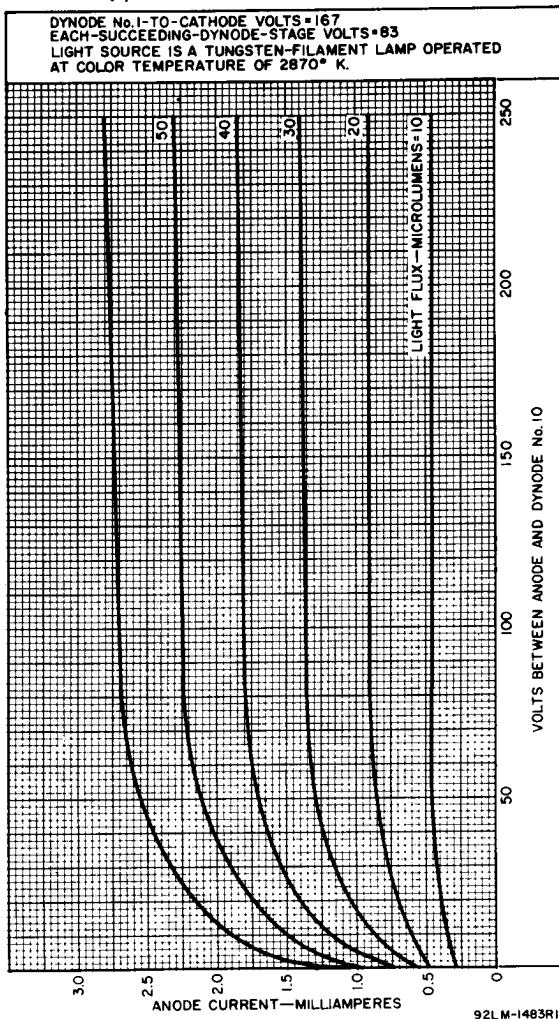

Typical Dark Current and EADCI Characteristics

LUMINOUS SENSITIVITY IS VARIED BY ADJUSTING THE SUPPLY VOLTAGE (E) ACROSS VOLTAGE DIVIDER WHICH PROVIDES 1/6 OF E BETWEEN CATHODE AND DYNODE No. 1; 1/12 OF E FOR EACH SUCCEEDING DYNODE STAGE; AND 1/2 OF E BETWEEN DYNODE No. 10 AND ANODE.
 TUBE TEMPERATURE = 22° C
 LIGHT SOURCE IS A TUNGSTEN-FILAMENT LAMP OPERATED AT A COLOR TEMPERATURE OF 2870° K.

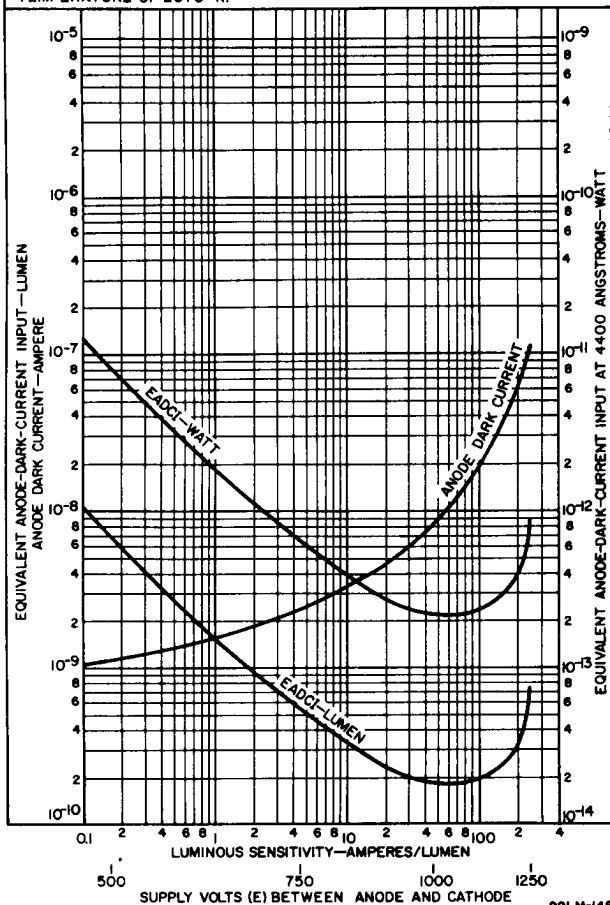

92LM-1485



Typical Time-Resolution Characteristics

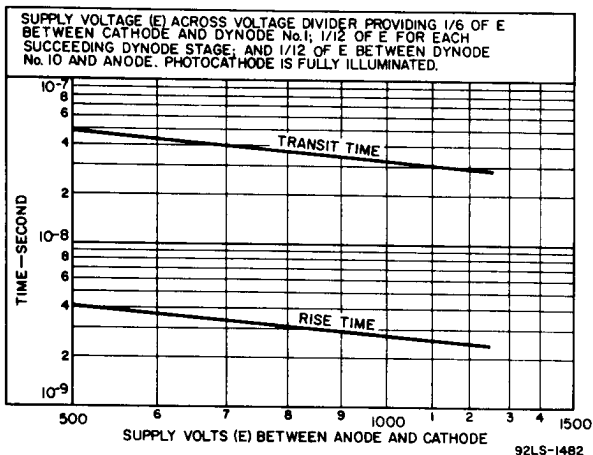

Typical ENI Characteristics

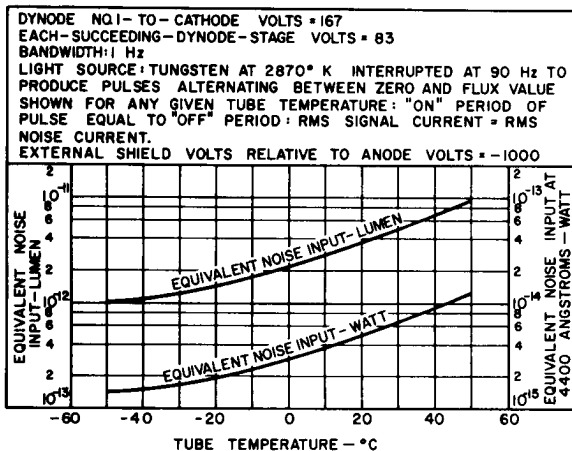

Spectral Energy Distribution of 2870°K Light Source After Passing Through Blue Filter

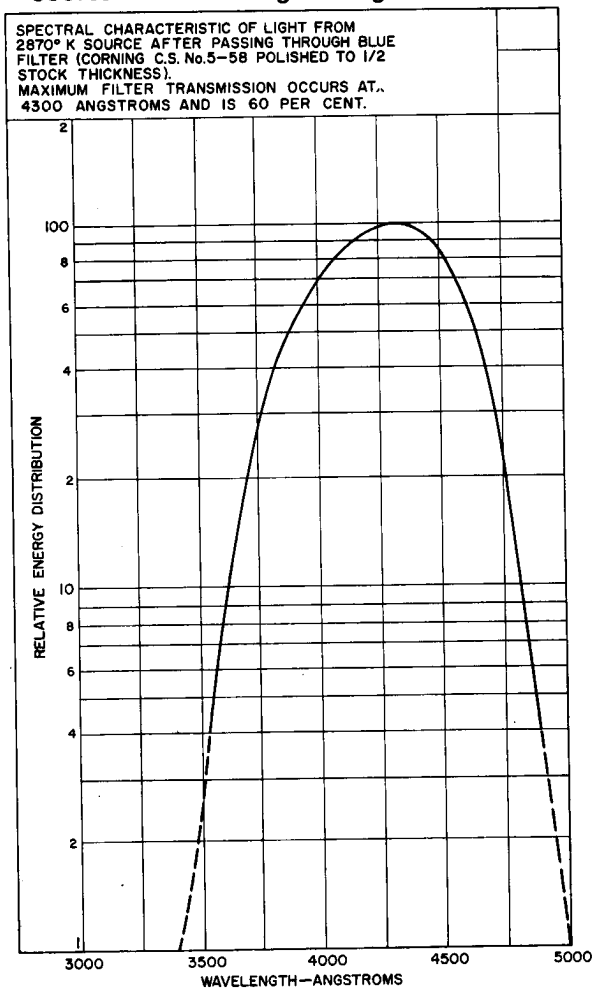

92CM-11081R1

