



6326

VIDICON

600-LINE RESOLUTION

For film pickup

with color or black-and-white TV cameras

6326

DATA

General:

Heater, for Unipotential Cathode:

Voltage 6.3 ± 10% ac or dc volts

Current 0.6 amp

Direct Interelectrode Capacitance:†

Target (Signal electrode) to all other electrodes. 4.5 μmf

Spectral Response See curves

Photoconductive Layer:

Maximum useful diagonal of rectangular image (4 x 3 aspect ratio). 0.62"

Orientation of quality rectangle—Proper orientation is obtained when the horizontal scan is essentially parallel to the plane passing through the tube axis and short index pin.

Focusing Method Magnetic

Deflection Method Magnetic

Overall Length. 6.25" ± 0.25"

Greatest Diameter (Excluding side tip). 1.125" ± 0.010"

Maximum Radius (Including side tip) 0.805"

Weight (Approx.). 2 oz

Operating Position. Approx. horizontal, or faceplate up

Bulb. T8

Base Connector. Cinch No.54A18088, or equivalent

Base. Small-Button Ditetra 8-Pin (JETEC No.E8-11)

Basing Designation for BOTTOM VIEW. 8HL ←

Pin 1—Heater

Pin 2—Grid No.1

Pin 3—Grid No.3

Pin 4—Internal Connection—Do Not Use

Pin 5—Grid No.2

Pin 6—Grid No.4, Grid No.5

Pin 7—Cathode

Pin 8—Heater

Flange—Target (Signal Electrode)

Short Index Pin—Internal Connection—Do Not Use

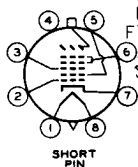

SHORT PIN

DIRECTION OF LIGHT: INTO FACE END OF TUBE

Maximum Ratings, Absolute Values:

For scanned area of 1/2" x 3/8"

GRID—No.5 & GRID—No.4 VOLTAGE 350 max. volts

GRID—No.3 VOLTAGE 350 max. volts

GRID—No.2 VOLTAGE 350 max. volts

† See next page.

← Indicates a change.



VIDICON

GRID—No.1 VOLTAGE:

Negative bias value.	125 max.	volts
Positive bias value.	0 max.	volts

PEAK HEATER—CATHODE VOLTAGE:

Heater negative with respect to cathode.	125 max.	volts
Heater positive with respect to cathode.	10 max.	volts

DARK CURRENT 0.025 max. μ a

PEAK TARGET (SIGNAL—ELECTRODE) CURRENT 0.5 max. μ a

FACEPLATE:

Illumination	1000 max.	ft-c
Temperature.	60 max.	$^{\circ}$ C

→ Typical Operation:

Grid No.3 connected to grids No.4 and No.5; scanned area of 1/2" x 3/8"; faceplate temperature of 30 $^{\circ}$ to 35 $^{\circ}$ C

Faceplate Illumination:

Average highlight [▲] , for pickup from film.	50 to 300	ft-c
Constant highlight, for pickup from live scenes	20	ft-c

Maximum Target (Signal—Electrode)

Voltage required to produce dark current of 0.02 μ a in any tube**	100	volts
--	-----	-------

Target (Signal—Electrode) Voltage:†

For pickup from film	20 to 40	volts
For pickup from live scenes.	40 to 70	volts

Grid—No.5 (Decelerator) and

Grids—No.4 & No.3 (Beam-Focus—Electrodes*) Voltage	250 [®] to 300	volts
--	-------------------------	-------

Grid—No.2 (Accelerator) Voltage. 300 volts

Grid—No.1 Voltage for picture cutoff[•] -45 to -100 volts

Signal—Output Current:*

Peak	0.3 to 0.4	μ a
Average.	0.1 to 0.2	μ a

Dark Current:

For pickup from film	0.004	μ a
For pickup from live scenes.	0.02	μ a

Average "Gamma" of Transfer

Characteristic for signal—output current between 0.02 μ a and 0.2 μ a	0.65	
---	------	--

Visual Equivalent Signal—to—Noise

Ratio (Approx.)^o 300:1

Minimum Peak—to—Peak Blanking Voltage:

When applied to grid No.1.	40	volts
When applied to cathode.	10	volts

Field Strength at Center of

Focusing Coil (Approx.). 40 gauss

Field Strength of Adjustable

Alignment Coil[□]. 0 to 4 gauss

▲, ▲, **, †, *, ⊕, ●, *, °, □: See next page.

→ Indicates a change.



6326

VIDICON

6326

- ▲ This capacitance, which effectively is the output impedance of the 6326, is increased when the tube is mounted in the deflecting-yoke and focusing-coil assembly. The resistive component of the output impedance is in the order of 100 megohms.
- ▲ Averaged over the time of one TV frame.
- ** The target (signal-electrode) voltage for each 6326 must be adjusted to that value which gives the desired operating dark current.
- † Indicated range for each type of service serves only to illustrate the operating target- (signal-electrode-) voltage range normally encountered.
- * Beam focus is obtained by combined effect of grids-No.4 & No.3 voltage which should be adjustable over indicated range, and a focusing coil having an average field strength of 40 gaussess. If desired, grid No.3 may be operated separately to permit vernier control of focus. Under such conditions, the instantaneous grid-No.3 voltage must always be equal to or greater than the grid-No.4 voltage.
- ⊕ Definition, focus uniformity, and picture quality decrease with decreasing grids-No.5 & No.4 & No.3 voltage. In general, grids No.5 & No.4 & No.3 should not be operated below 250 volts.
- With no blanking voltage on grid No.1.
- # Defined as the component of the target (signal-electrode) current after the dark-current component has been subtracted.
- Measured with high-gain, low-noise, cascode-type amplifier having bandwidth of 5 MC. Because the noise in such a system is predominately of the high-frequency type, the visual equivalent signal-to-noise ratio is taken as the ratio of highlight video-signal current to rms noise current, multiplied by a factor of 3.
- The alignment coil should be located on the tube so that its center is at a distance of 3-11/16 inches from the face of the tube, and be positioned so that its axis is coincident with the axis of the tube, the deflecting yoke, and the focusing coil.

DATA 2

TYPICAL CHARACTERISTIC

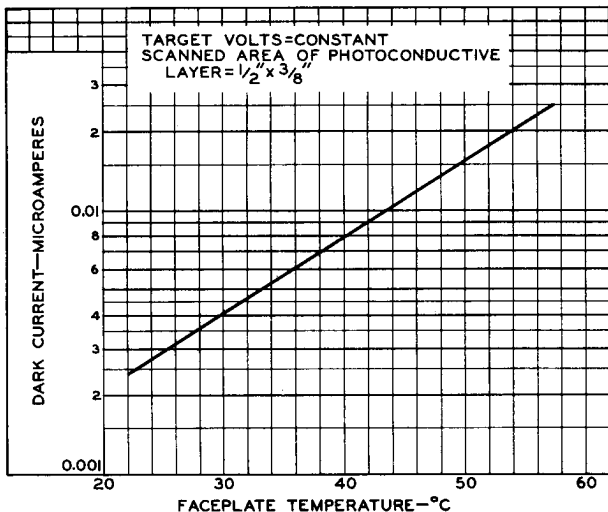

6326



6326 VIDICON

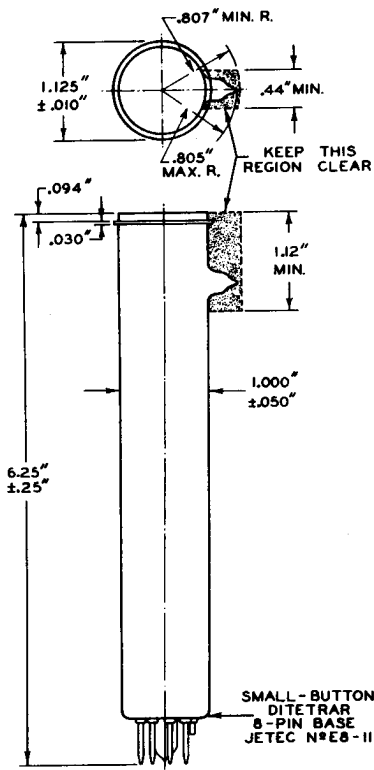

92CS-7772R2



6326

6326

SPECTRAL-SENSITIVITY CHARACTERISTICS

CURVE A: FOR EQUAL VALUES OF SIGNAL-
 OUTPUT CURRENT AT ALL WAVELENGTHS.
 SIGNAL-OUTPUT MICROAMPERES FROM
 SCANNED AREA OF $\frac{1}{2}'' \times \frac{3}{8}'' = 0.02$
 DARK CURRENT (MICROAMPERES) = 0.02

CURVE B: SPECTRAL CHARACTERISTIC OF
 AVERAGE HUMAN EYE .

CURVE C: FOR EQUAL VALUES OF SIGNAL-
 OUTPUT CURRENT WITH RADIANT
 FLUX FROM TUNGSTEN SOURCE
 AT 2870° K.

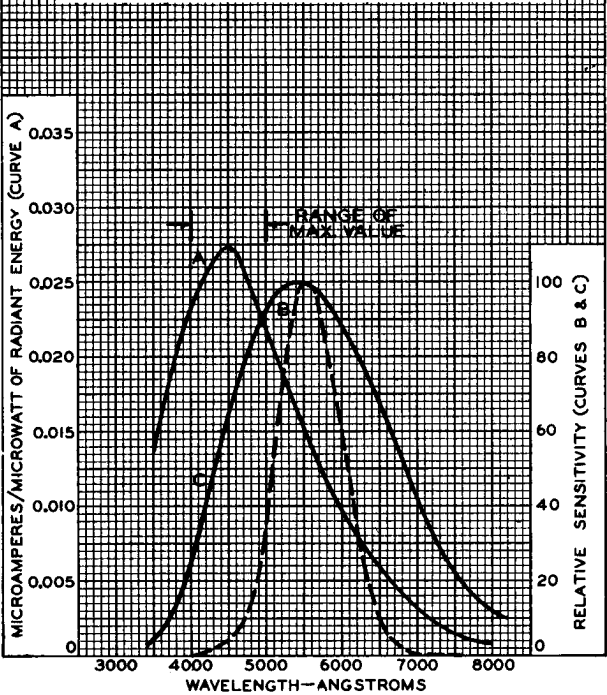

← WAVELENGTH—ANGSTROMS →

ULTRA VIOLET VIOLET BLUE GREEN YELLOW RED INFRA RED

6326



6326

TYPICAL LIGHT-TRANSFER CHARACTERISTICS

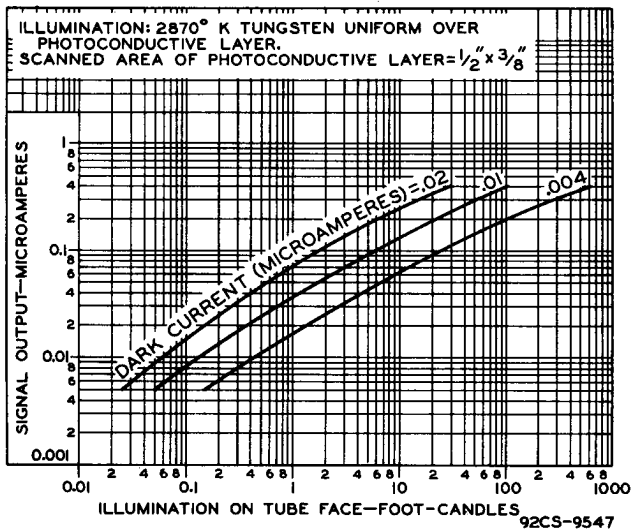

TYPICAL PERSISTENCE CHARACTERISTIC

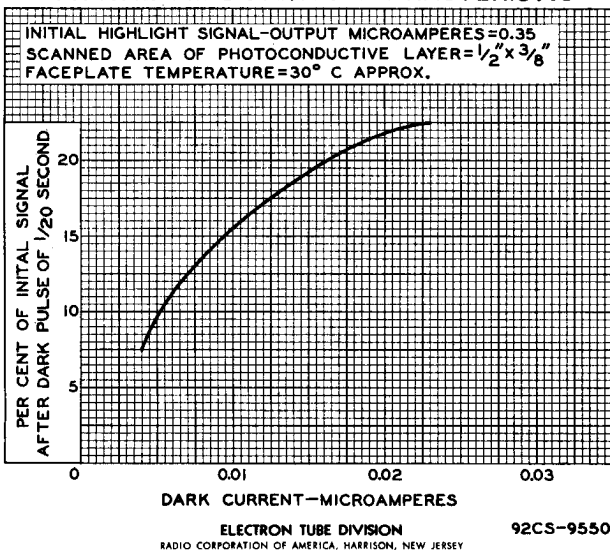



6326

6326

TYPICAL CHARACTERISTIC

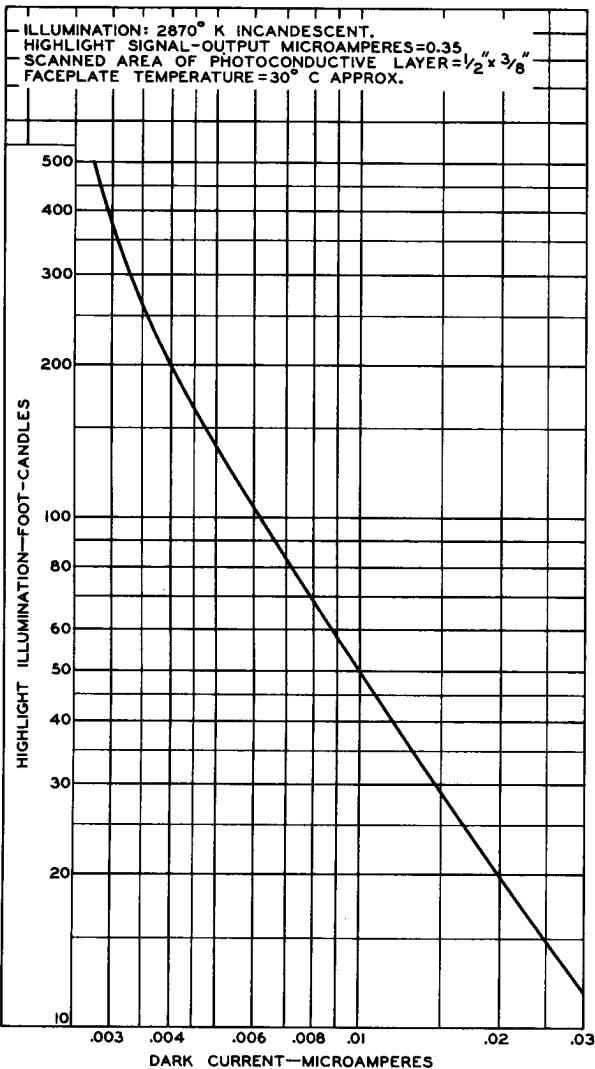

DARK CURRENT—MICROAMPERES

ELECTRON TUBE DIVISION

92CM-9545

RADIO CORPORATION OF AMERICA, HARRISON, NEW JERSEY

6326



6326

TYPICAL DARK-CURRENT CHARACTERISTIC

SCANNED AREA OF PHOTOCONDUCTIVE LAYER = $\frac{1}{2}'' \times \frac{3}{8}''$
FACEPLATE TEMPERATURE = 30° C APPROX.

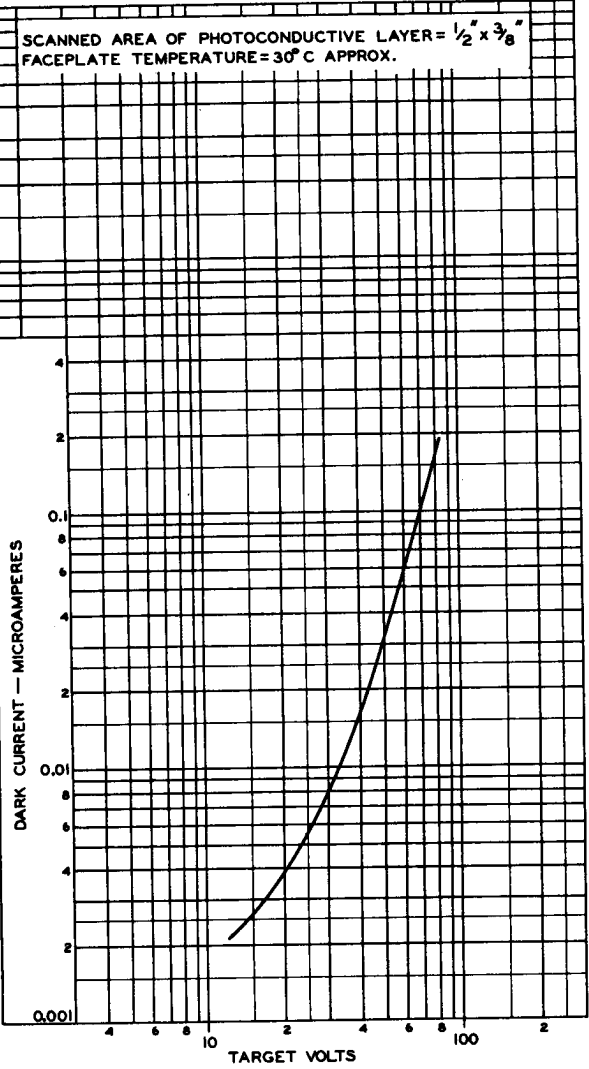



6326

6326

TYPICAL CHARACTERISTICS

HIGHLIGHT SIGNAL-OUTPUT MICROAMPERES=0.3
DARK CURRENT (MICROAMPERES)=0.004
SCANNED AREA OF PHOTOCONDUCTIVE LAYER= $\frac{1}{2} \times \frac{3}{8}$ "
CURVE A: TARGET VOLTAGE REQUIRED TO MAINTAIN
DARK CURRENT OF 0.004 μ A.
CURVE B: 2870° K INCANDESCENT ILLUMINATION
REQUIRED TO PRODUCE SIGNAL-OUTPUT
CURRENT OF 0.3 μ A.

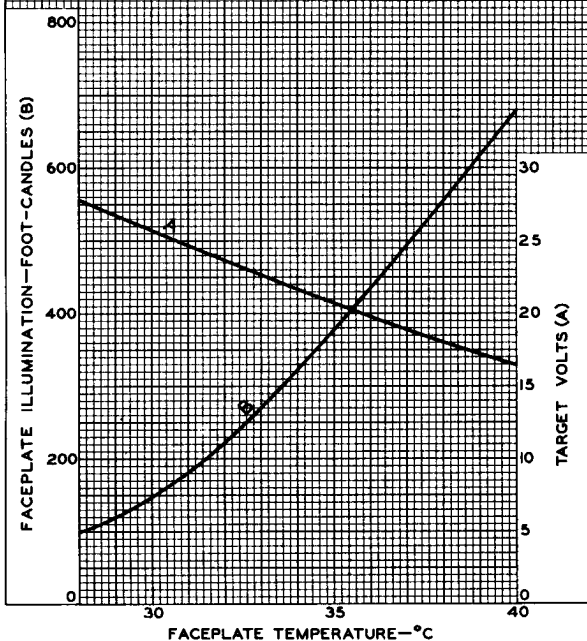

ELECTRON TUBE DIVISION

RADIO CORPORATION OF AMERICA, HARRISON, NEW JERSEY

92CM-9543