

## Beam Power Tube

## FORCED-AIR COOLED

CERAMIC-METAL SEALS

380 WATTS PEP OUTPUT AT 30 Mc

COAXIAL ELECTRODE STRUCTURE

300 WATTS CW OUTPUT AT 470 Mc

UNIPOENTIAL CATHODE

INTEGRAL RADIATOR

Full Ratings up to 500 Mc

## GENERAL DATA

## Electrical:

Heater, for Unipotential Cathode:

Voltage (AC or DC) <sup>a</sup> . . . . .	13.5 ± 10%	volts
Current at 13.5 volts. . . . .	1.3	amp
Minimum heating time . . . . .	60	sec

Mu-Factor, Grid No.2 to Grid No.1

for plate volts = 450, grid-No.2

volts = 325, plate amperes = 1.2 . . . . . 12

Direct Interelectrode Capacitances:<sup>b</sup>

Grid No.1 to plate . . . . .	0.13 max.	μf
Grid No.1 to cathode . . . . .	16	μf
Plate to cathode . . . . .	0.011	μf
Grid No.1 to grid No.2 . . . . .	22	μf
Grid No.2 to plate . . . . .	6.5	μf
Grid No.2 to cathode . . . . .	3.2	μf
Cathode to heater. . . . .	3.4	μf

## Mechanical:

Operating Position . . . . .	. . . . .	Any
Maximum Overall Length . . . . .	. . . . .	2.26"
Seated Length. . . . .	1.920" ± 0.065"	
Diameter . . . . .	1.625" ± 0.015"	
Weight (Approx.) . . . . .	. . . . .	3.5 oz
Socket . . . . .	Mycalex <sup>c</sup> No. CP464-2, or equivalent	
Base . . . . .	Large-Wafer Elevenar 11-Pin with Ring (JEDEC No. E11-81)	

Terminal Connections (See *Dimensional Outline*):

## BOTTOM VIEW

- Pin 1 - Cathode
- Pin 2 - Grid No.2
- Pin 3 - Grid No.1
- Pin 4 - Cathode
- Pin 5 - Heater
- Pin 6 - Heater
- Pin 7 - Grid No.2
- Pin 8 - Grid No.1
- Pin 9 - Cathode
- Pin 10 - Grid No.2

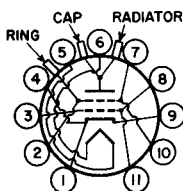

- Pin 11 - Grid No.1
- CAP - Plate Terminal
- RADIATOR - Plate Terminal
- RING<sup>d</sup> - Grid-No.2 Terminal Contact Surface

## Thermal:

Terminal Temperature (All terminals) . . . . .	250 max.	°C
Radiator Core Temperature (See <i>Dimensional Outline</i> ) . . . . .	250 max.	°C



## Air Flow:

See accompanying *Typical Cooling Requirements* curve.

**LINEAR RF POWER AMPLIFIER**  
**Single-Sideband Suppressed-Carrier Service**

*Peak envelope conditions for a signal having  
a minimum peak-to-average power ratio of 2*

**Maximum CCS Ratings, Absolute-Maximum Values:**

Up to 500 Mc

DC PLATE VOLTAGE. . . . .	2200	max.	volts
DC GRID-No.2 VOLTAGE. . . . .	400	max.	volts
DC GRID-No.1 VOLTAGE. . . . .	-100	max.	volts
DC PLATE CURRENT AT PEAK OF ENVELOPE. . . . .	450 <sup>e</sup>	max.	ma
DC GRID-No.1 CURRENT. . . . .	100	max.	ma
PLATE DISSIPATION . . . . .	400	max.	watts
GRID-No.2 DISSIPATION . . . . .	8	max.	watts
<b>PEAK HEATER-CATHODE VOLTAGE:</b>			
Heater negative with respect to cathode.	150	max.	volts
Heater positive with respect to cathode.	150	max.	volts

**Typical CCS Operation with "Two-Tone Modulation":**

At 30 Mc

DC Plate Voltage. . . . .	2000		volts
DC Grid-No.2 Voltage <sup>f</sup> . . . . .	400		volts
DC Grid-No.1 Voltage <sup>f</sup> . . . . .	-35		volts
Zero-Signal DC Plate Current. . . . .	100		ma
Effective RF Load Resistance. . . . .	3050		ohms
<b>DC Plate Current:</b>			
Peak of envelope. . . . .	335		ma
Average . . . . .	250		ma
<b>DC Grid-No.2 Current:</b>			
Peak of envelope. . . . .	10		ma
Average . . . . .	7		ma
Average DC Grid-No.1 Current. . . . .	0.05 <sup>g</sup>		ma
<b>Peak-of-Envelope Driver Power Output</b>			
(Approx.) <sup>h</sup> . . . . .	0.3		watt
<b>Output-Circuit Efficiency (Approx.) . . . . .</b>			
	90		%
<b>Distortion Products Level:<sup>j</sup></b>			
Third order . . . . .	29		db
Fifth order . . . . .	32		db
<b>Useful Power Output (Approx.):</b>			
Peak of envelope. . . . .	380 <sup>k</sup>		watts
Average . . . . .	190 <sup>k</sup>		watts

**Maximum Circuit Values:**Grid-No.1 Circuit Resistance  
under any condition:

With fixed bias . . . . .	25000	max.	ohms
With fixed bias (In Class-AB <sub>1</sub> operation). . . . .	100000	max.	ohms
With cathode bias . . . . .	Not	recommended	
Grid-No.2-Circuit Impedance . . . . .	10000	max.	ohms
Plate-Circuit Impedance . . . . .	m		



## RF POWER AMPLIFIER & OSCILLATOR — Class C Telegraphy and

### RF POWER AMPLIFIER — Class C FM Telephony

**Maximum CCS Ratings, Absolute-Maximum Values:**

	<i>Up to 500 Mc</i>	
DC PLATE VOLTAGE. . . . .	2200 max.	volts
DC GRID-No.2 VOLTAGE. . . . .	400 max.	volts
DC GRID-No.1 VOLTAGE. . . . .	-100 max.	volts
DC PLATE CURRENT. . . . .	300 max.	ma
DC GRID-No.1 CURRENT. . . . .	100 max.	ma
GRID-No.2 DISSIPATION . . . . .	8 max.	watts
PLATE DISSIPATION . . . . .	400 max.	watts
<b>PEAK HEATER-CATHODE VOLTAGE:</b>		
Heater negative with respect to cathode.	150 max.	volts
Heater positive with respect to cathode.	150 max.	volts

**Typical CCS Operation:**

*In grid-drive circuit at 50 Mc*

DC Plate Voltage. . . . .	700	1000	1500	2000	volts
DC Grid-No.2 Voltage. . . . .	175	200	200	200	volts
DC Grid-No.1 Voltage. . . . .	-10	-30	-30	-30	volts
DC Plate Current. . . . .	300	300	300	300	ma
DC Grid-No.2 Current. . . . .	25	20	20	20	ma
DC Grid-No.1 Current. . . . .	50	40	40	30	ma
Driver Power Output (Approx.) <sup>n</sup> .	1.2	2	2	2	watts
Useful Power Output . . . . .	120 <sup>k</sup>	175 <sup>k</sup>	275 <sup>k</sup>	375 <sup>k</sup>	watts

*In grid-drive circuit at 470 Mc*

DC Plate Voltage. . . . .	700	1000	1500	2000	volts
DC Grid-No.2 Voltage. . . . .	200	200	200	200	volts
DC Grid-No.1 Voltage. . . . .	-30	-30	-30	-30	volts
DC Plate Current. . . . .	300	300	300	300	ma
DC Grid-No.2 Current. . . . .	10	10	5	5	ma
DC Grid-No.1 Current. . . . .	30	30	30	30	ma
Driver Power Output (Approx.) <sup>n</sup> .	5	5	5	5	watts
Useful Power Output . . . . .	100 <sup>p</sup>	165 <sup>p</sup>	235 <sup>p</sup>	300 <sup>p</sup>	watts

**Maximum Circuit Values:**

Grid-No.1 Circuit Resistance

under any condition:

With fixed bias . . . . . 25000 max. ohms

Grid-No.2-Circuit Impedance . . . . . 10000 max. ohms

Plate-Circuit Impedance . . . . . m

<sup>a</sup> Because the cathode is subjected to back bombardment as the frequency is increased with resultant increase in temperature, the heater voltage should, for optimum life, be reduced to a value such that at the heater voltage obtained at minimum supply voltage conditions (all other voltages constant) the tube performance just starts to show some degradation; e.g., at 470 Mc, heater volts = 12.5 (approx.).

<sup>b</sup> Measured with special shield adapter.

<sup>c</sup> Mycalex Corporation of America, 125 Clifton Boulevard, Clifton, New Jersey.

<sup>d</sup> For use at higher frequencies.

<sup>e</sup> The maximum rating for a signal having a minimum peak-to-average power ratio less than 2, such as is obtained in "Single-Tone" operation, is



300 ma. During short periods of circuit adjustment under "Single-Tone" conditions, the average plate current may be as high as 450 ma.

f Obtained preferably from a separate, well-regulated source.

g This value represents the approximate grid-No.1 current obtained due to initial electron velocities and contact-potential effects when grid No.1 is driven to zero volts at maximum signal.

h Driver power output represents circuit losses and is the actual power measured at input to grid No.1 circuit. The actual power required depends on the operating frequency and the circuit used. The tube driving power is approximately zero watts.

j With maximum signal output used as a reference, and without the use of feedback to enhance linearity.

k This value of useful power is measured at load of output circuit.

m The tube should see an effective plate supply impedance which limits the peak current through the tube under surge conditions to 15 amperes.

n Driver power output includes circuit losses and is the actual power measured at the input to the grid circuit. It will vary depending upon the frequency of operation and the circuit used.

o Measured in a typical coaxial-cavity circuit.

### CHARACTERISTICS RANGE VALUES

Test No.	Note	Min.	Max.	
1. Heater Current . . . . .	1	1.15	1.45	amp
2. Direct Interelectrode Capacitances:	2			
Grid No.1 to plate . . . . .	-	—	0.13	$\mu\text{f}$
Grid No.1 to cathode . . . . .	-	14.3	17.7	$\mu\text{f}$
Plate to cathode . . . . .	-	0.0065	0.0155	$\mu\text{f}$
Grid No.1 to grid No.2 . . . . .	-	19.8	24.2	$\mu\text{f}$
Grid No.2 to plate . . . . .	-	5.7	7.1	$\mu\text{f}$
Grid No.2 to cathode . . . . .	-	2.6	3.6	$\mu\text{f}$
Cathode to heater . . . . .	-	2.5	4.1	$\mu\text{f}$
3. Grid-No.1 Voltage . . . . .	1,3	-8	-19	volts
4. Reverse Grid-No.1 Current . . . . .	1,3	—	-25	$\mu\text{a}$
5. Grid-No.2 Current . . . . .	1,3	-7	+6	ma
6. Peak Emission . . . . .	1,4	13	—	peak amp
7. Interelectrode Leakage Resistance . . . . .	5	1	—	megohm

Note 1: With 13.5 volts ac or dc on heater.

Note 2: Measured with special shield adapter.

Note 3: With dc plate voltage at 700 volts, dc grid-No.2 voltage of 250 volts, and dc grid-No.1 voltage adjusted to give a dc plate current of 185 ma.

Note 4: For conditions with grid No.1, grid No.2, and plate tied together; and pulse voltage source connected between plate and cathode. Pulse duration is 2.5 microseconds and pulse repetition frequency is 60 pps. The voltage-pulse amplitude is 200 volts peak. After 1 minute at this value, the current-pulse amplitude will not be less than the value specified.

Note 5: Under conditions with tube at 20° to 30° C for at least 30 minutes without any voltages applied to the tube. The minimum resistance between any two electrodes as measured with a 200-volt Megger-type ohmmeter having an internal impedance of 1 megohm, will be 1 megohm.



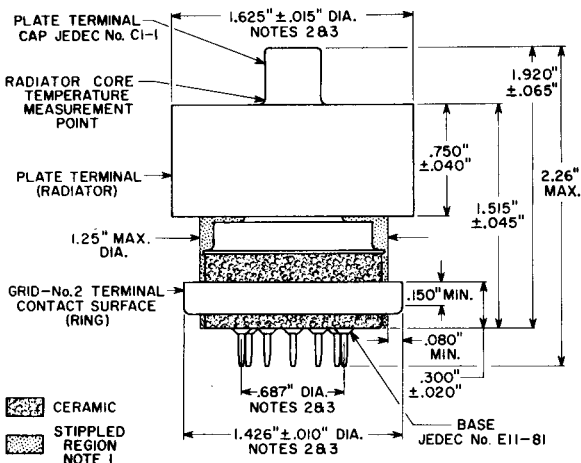

92CS-11304RI

**NOTE 1:** KEEP ALL STIPPLED REGIONS CLEAR. DO NOT ALLOW CONTACTS OR CIRCUIT COMPONENTS TO PROTRUDE INTO THESE ANNULAR VOLUMES.

**NOTE 2:** THE DIAMETERS OF THE RADIATOR, GRID-No.2 TERMINAL CONTACT SURFACE, AND PIN CIRCLE TO BE CONCENTRIC WITHIN THE FOLLOWING VALUES OF MAXIMUM FULL INDICATOR READING:

Radiator to Grid-No.2

Terminal Contact Surface . . . . . 0.030" max.

Radiator to Pin Circle . . . . . 0.040" max.

Grid-No.2 Terminal Contact

Surface to Pin Circle . . . . . 0.030" max.

**NOTE 3:** THE FULL INDICATOR READING IS THE MAXIMUM DEVIATION IN RADIAL POSITION OF A SURFACE WHEN THE TUBE IS COMPLETELY ROTATED ABOUT THE CENTER OF THE REFERENCE SURFACE. IT IS A MEASURE OF THE TOTAL EFFECT OF RUN-OUT AND ELLIPTICITY.



## TYPICAL COOLING REQUIREMENTS

AIR FLOW DIRECTED THROUGH RADIATOR WITH AIR CHIMNEY SK-606 (EITEL-McCULLOUGH INC.), AND SOCKET CD464-2 (MYCALEX CORP. OF AMERICA), AND BY-PASS CAPACITOR (E.F. JOHNSON CO.)  
 PLATE-CORE TEMPERATURE — 250° C.  
 INCOMING-AIR TEMPERATURE — 24° C.

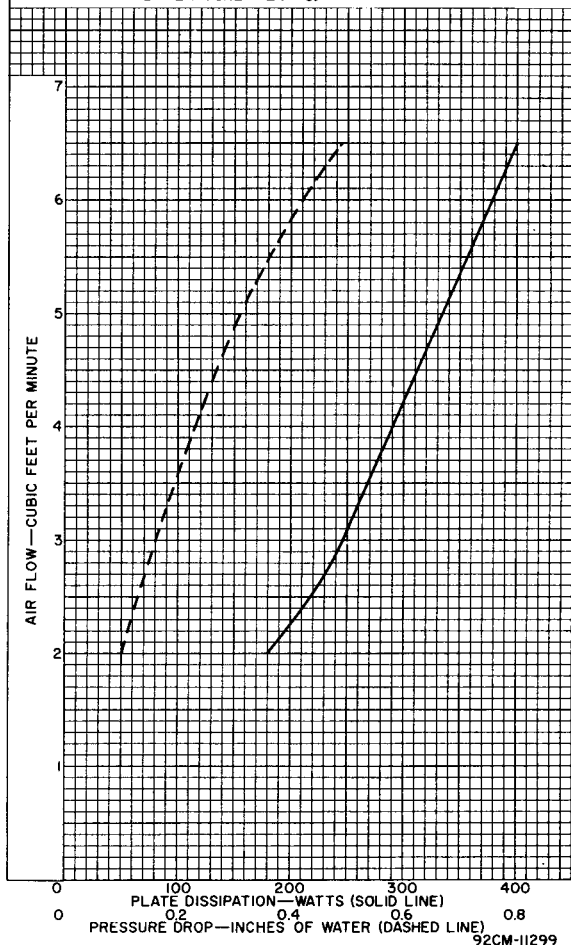

## TYPICAL PLATE CHARACTERISTICS

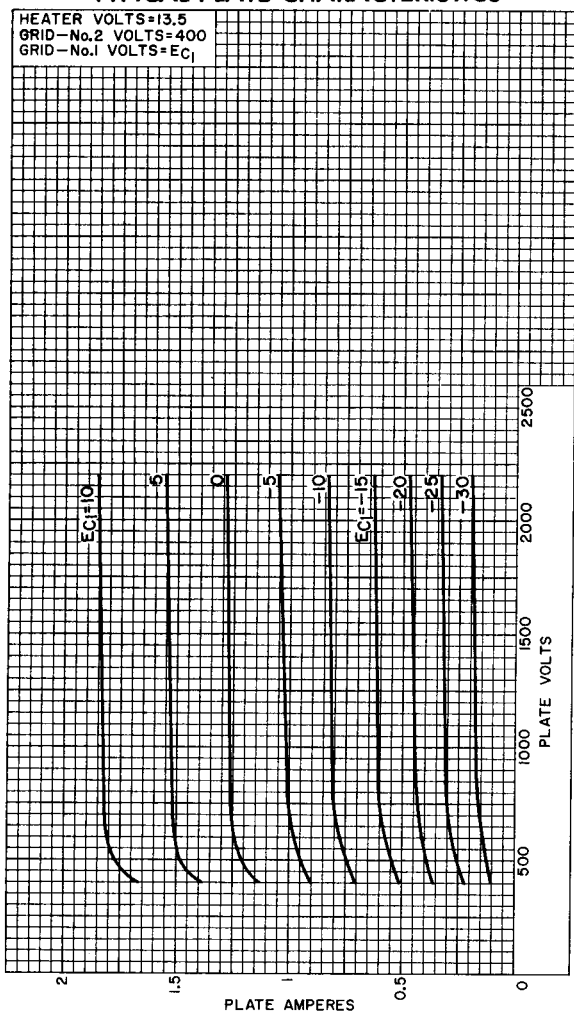

92CM-11290



## TYPICAL PLATE CHARACTERISTICS

HEATER VOLTS = 13.5  
GRID—No. 2 VOLTS = 250  
GRID—No. 1 VOLTS =  $E_{c1}$

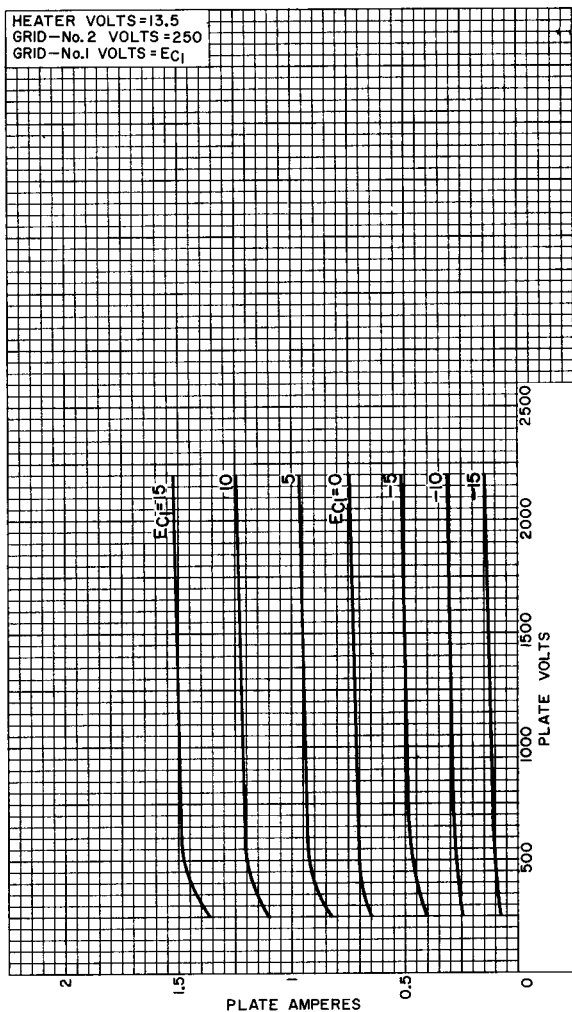

92CM-11288





## TYPICAL PLATE CHARACTERISTICS

HEATER VOLTS=13.5  
 GRID—No.2 VOLTS=150  
 GRID—No.1 VOLTS= $E_{C1}$

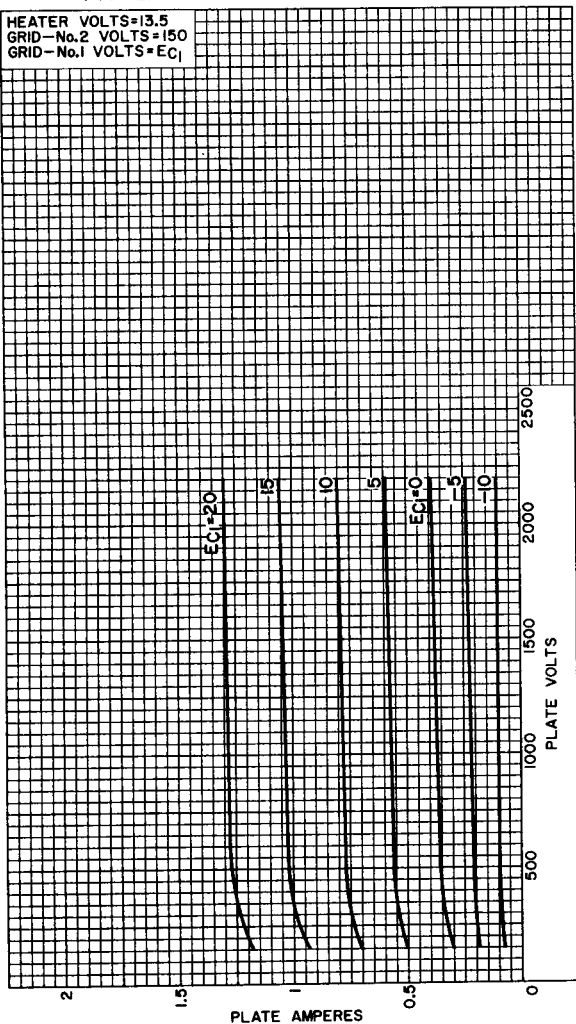

92CM-11289



## TYPICAL CHARACTERISTICS

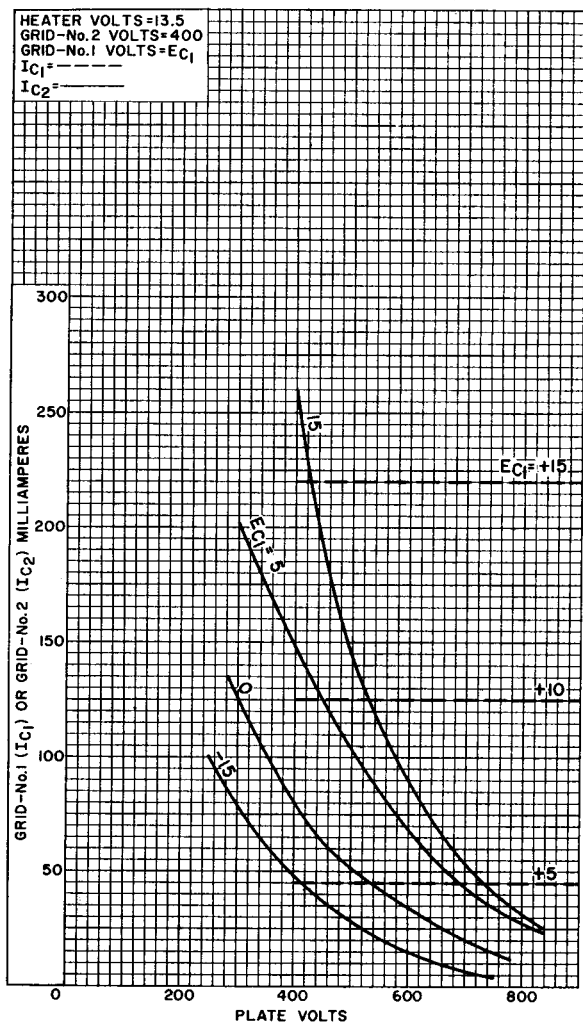

92CM-11293RI



## TYPICAL CHARACTERISTICS

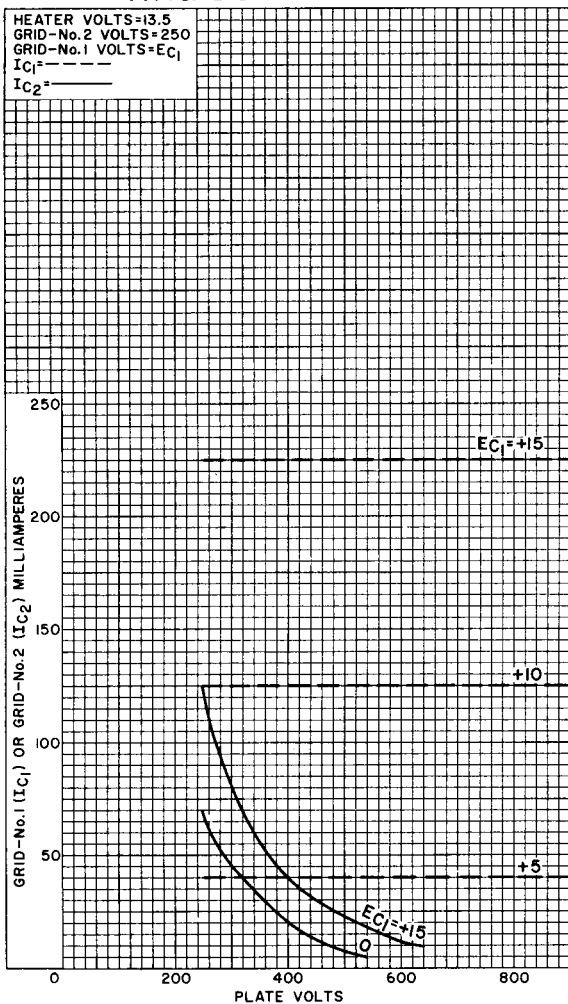

92CM-11291



## TYPICAL CHARACTERISTICS

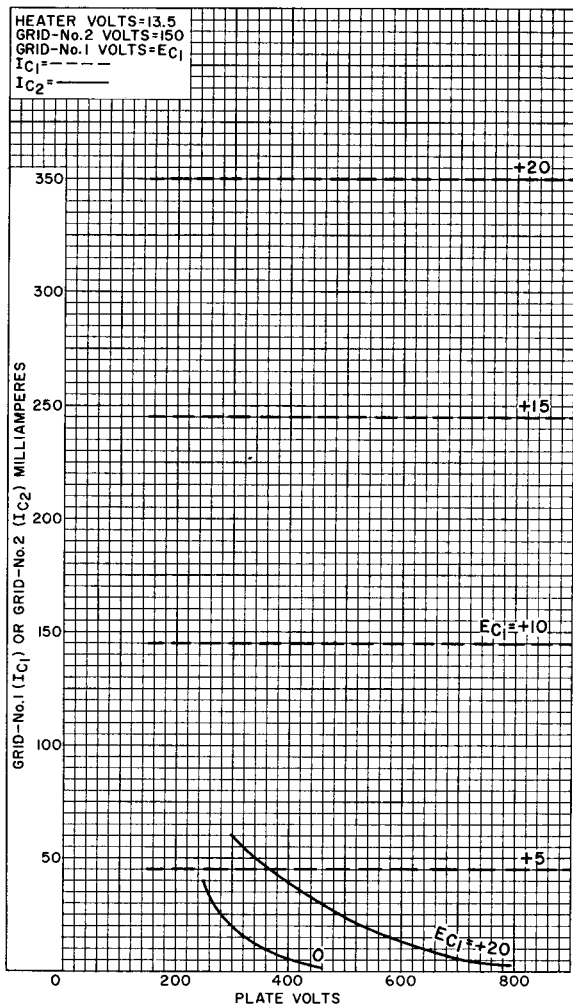

92CM-11292



# Beam Power Tube

FORCED-AIR COOLED

INTEGRAL RADIATOR

CERAMIC-METAL SEALS

380 WATTS PEP OUTPUT AT 30 MHz AB<sub>1</sub>

COAXIAL ELECTRODE STRUCTURE

570 WATTS PEP OUTPUT AT 30 MHz AB<sub>2</sub>

UNIPOTENTIAL CATHODE

300 WATTS CW OUTPUT AT 470 MHz

For Use as an RF Power Amplifier, Oscillator, Regulator, Distributed Amplifier or Linear RF Power Amplifier in Mobile or Fixed Equipment

## ELECTRICAL

### Heater, for Unipotential Cathode<sup>d</sup>

Voltage (AC or DC) <sup>a</sup> . . . . .	13.5 ± 10%	V
Current at 13.5 volts . . . . .	1.3	A
Minimum heating time . . . . .	60	s

### Mu-Factor, Grid No.2 to Grid No.1 . . . . . 12

Plate volts = 450, grid-No.2 volts = 325,  
plate amperes = 1.2

### Direct Interelectrode Capacitances<sup>b</sup>

Grid No.1 to plate . . . . .	0.13 max	pF
Grid No.1 to cathode . . . . .	16	pF
Plate to cathode . . . . .	0.011	pF
Grid No.1 to grid No.2 . . . . .	24	pF
Grid No.2 to plate . . . . .	7	pF
Grid No.2 to cathode . . . . .	2.6	pF
Cathode to heater . . . . .	3.4	pF

## MECHANICAL

Operating Position . . . . .	Any
Maximum Overall Length . . . . .	2.26 in
Seated Length . . . . .	1.920 ± 0.065 in
Diameter . . . . .	1.625 ± 0.015 in
Weight (Approx.) . . . . .	3.5 oz
Socket . . . . .	Erie <sup>c</sup> No.9802-000 and 9804-000, Johnson <sup>d</sup>

No.124-311-110, Mycalex<sup>e</sup> No.CP464-2, or equivalent

Grid No.2 Bypass Capacitor . . . . .	Erie <sup>c</sup> No.2943-002, Johnson <sup>d</sup>
	No.124-121, or equivalent

Base . . . . . Large-Wafer Elevenar 11-Pin with Ring (JEDEC No.E11-81)

## TERMINAL DIAGRAM (Bottom View)

Pin 1 - Cathode  
Pin 2 - Grid No.2  
Pin 3 - Grid No.1  
Pin 4 - Cathode  
Pin 5 - Heater  
Pin 6 - Heater  
Pin 7 - Grid No.2  
Pin 8 - Grid No.1  
Pin 9 - Cathode  
Pin 10 - Grid No.2

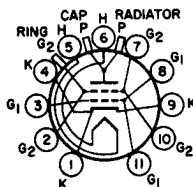

Pin 11 - Grid No.1

CAP - Plate

Terminal

RADIATOR - Plate

Terminal

RING - Grid-No.2

Terminal

Contact

Surface

(For use at

higher

frequencies)

## THERMAL

Terminal Temperature (All Terminals) . . . . . 250 max °C

Radiator Core Temperature

See *Dimensional Outline* . . . . . 250 max °C

Air Flow<sup>g</sup> (See accompanying *Typical Cooling Requirements* curve).



RADIO CORPORATION OF AMERICA  
Electronic Components and Devices  
Harrison, N. J.

DATA 1  
10-66

LINEAR RF POWER AMPLIFIER<sup>f</sup>

## Single-Sideband Suppressed-Carrier Service

Peak envelope conditions for a signal having  
a minimum peak-to-average power ratio of 2

## Maximum CCS Ratings, Absolute-Maximum Values

## → DC Plate Voltage

Up to 30 MHz . . . . .	3000 <sup>f</sup>	V
Up to 500 MHz . . . . .	2200	V

Up to 500 MHz

DC Grid-No.2 Voltage . . . . .	400	V
DC Grid-No.1 Voltage . . . . .	-100	V
DC Plate Current at Peak of Envelope . . . . .	450 <sup>g</sup>	mA
DC Grid-No.1 Current . . . . .	100	mA
Plate Dissipation . . . . .	400	W
Grid-No.2 Dissipation . . . . .	8	W
Peak Heater-Cathode Voltage . . . . .	±150	V

## Typical CCS Operation at 30 MHz with "Two-Tone Modulation"

	AB <sub>1</sub>	AB <sub>2</sub>	
DC Plate Voltage . . . . .	2000	2500	V
DC Grid-No.2 Voltage . . . . .	400	400	V
DC Grid-No.1 Voltage . . . . .	-35	-35	V
Zero-Signal DC Plate Current . . . . .	100	115	mA
Effective RF Load Resistance . . . . .	3050	3500	Ω
DC Plate Current			
Peak of envelope . . . . .	335	400	mA
Average . . . . .	250	275	mA
DC Grid-No.2 Current			
Peak of envelope . . . . .	10	6	mA
Average . . . . .	7	4	mA
Average DC Grid-No.1 Current . . . . .	0.05 <sup>h</sup>	3	mA
Peak-of-Envelope Driver Power Output (Approx.)	0.3	0.5	W
Output-Circuit Efficiency (Approx.) . . . . .	90	90	%
Distortion Products Level			
Third order . . . . .	29 <sup>j</sup>	28	dB
Fifth order . . . . .	32	32	dB
Useful Power Output (Approx.)			
Peak of envelope . . . . .	380	570	W
Average . . . . .	190	285	W

## Maximum Circuit Values

Grid-No.1 Circuit Resistance Under Any Condition <sup>k</sup>		
With fixed bias . . . . .	25000	Ω
With fixed bias (In Class-AB <sub>2</sub> operation) . . . . .	100000	Ω
With cathode bias . . . . .	Not recommended	
Grid-No.2-Circuit Impedance <sup>m</sup> . . . . .	10000	Ω
Plate-Circuit Impedance <sup>f</sup> . . . . .	n	

PLATE-MODULATED RF POWER AMPLIFIER - Class C Telephony<sup>r</sup>

Carrier conditions: per tube for use with a maximum modulation factor of 1

## Maximum CCS Ratings, Absolute-Maximum Values

	Up to 500 MHz	
DC Plate Voltage . . . . .	1800	V
DC Grid-No.2 Voltage . . . . .	400	V
DC Grid-No.1 Voltage . . . . .	-100	V



DC Plate Current . . . . .	250	mA
DC Grid-No.1 Current . . . . .	100	mA
Grid-No.2 Input. . . . .	5	W
Plate Dissipation. . . . .	280	W

RF POWER AMPLIFIER & OSCILLATOR - Class C Telegraphy<sup>r</sup>  
and

RF POWER AMPLIFIER - Class C FM Telephony<sup>r</sup>

Maximum CCS Ratings, Absolute-Maximum Values

	Up to 500 MHz	
DC Plate Voltage . . . . .	2200	V
DC Grid-No.2 Voltage . . . . .	400	V
DC Grid-No.1 Voltage . . . . .	-100	V
DC Plate Current . . . . .	300	mA
DC Grid-No.1 Current . . . . .	100	mA
Grid-No.2 Dissipation. . . . .	8	W
Plate Dissipation. . . . .	400	W
Peak Heater-Cathode Voltage. . . . .	±150	V

Typical CCS Operation

*In grid-drive circuit at 50 MHz*

DC Plate Voltage . . . . .	700	1000	1500	2000	V
DC Grid-No.2 Voltage . . . . .	175	200	200	200	V
DC Grid-No.1 Voltage . . . . .	-10	-30	-30	-30	V
DC Plate Current . . . . .	300	300	300	300	mA
DC Grid-No.2 Current . . . . .	25	20	20	20	mA
DC Grid-No.1 Current . . . . .	50	40	40	30	mA
Driver Power Output (Approx.). . . . .	1.2	2	2	2	W
Useful Power Output. . . . .	120	175	275	375	W

*In grid-drive circuit at 470 MHz*

DC Plate Voltage . . . . .	700	1000	1500	2000	V
DC Grid-No.2 Voltage . . . . .	200	200	200	200	V
DC Grid-No.1 Voltage . . . . .	-30	-30	-30	-30	V
DC Plate Current . . . . .	300	300	300	300	mA
DC Grid-No.2 Current . . . . .	10	10	5	5	mA
DC Grid-No.1 Current . . . . .	30	30	30	30	mA
Driver Power Output (Approx.). . . . .	5	5	5	5	W
Useful Power Output. . . . .	100	165	235	300	W

Maximum Circuit Values

Grid-No.1 Circuit Resistance Under Any Condition

With fixed bias. . . . . 25000 Ω

Grid-No.2-Circuit Impedance. . . . . 10000 Ω

Plate-Circuit Impedance. . . . . n

<sup>a</sup> Because the cathode is subjected to back bombardment as the frequency is increased with resultant increase in temperature, the heater voltage should, for optimum life, be reduced to a value such that at the heater voltage obtained at minimum supply voltage conditions (all other voltages constant) the tube performance just starts to show some degradation; e.g., at 470 MHz, heater volts = 12.5 (approx.).

<sup>b</sup> Measured with special shield adapter.

<sup>c</sup> Eric Technological Products, Inc., 645 West 12th Street, Erie, Pa.

<sup>d</sup> E. F. Johnson Co., 1921 19th Ave. S.W. Waseca, Minn.

<sup>e</sup> Myralox Corporation of America, 775 Clifton Boulevard, Clifton.

<sup>f</sup> For operation above 2200 plate volts, the tube shall see an effective plate-supply impedance of no less than 750 ohms. A fault current



limiting resistor of no less than 15 ohms is to be used between the output filter capacitance and the tube plate. The plate-supply-output-filter capacitance is to be no greater than 10  $\mu\text{F}$ .

- g The maximum rating for a signal having a minimum peak-to-average power ratio less than 2, such as is obtained in "Single-Tone" operation, is 300 mA. During short periods of circuit adjustment under "Single-Tone" conditions, the average plate current may be as high as 450 mA.
- h This value represents the approximate grid-No.1 current obtained due to initial electron velocities and contact-potential effects when grid No.1 is driven to zero volts at maximum signal.
- j The value of third order distortion product level shown may be improved by approximately 5 dB by utilizing an unbypassed, non-inductive 20-ohm resistor between the cathode and ground; a slight increase in drive power will be required.
- k A fault current limiting resistor of no less than 20 ohms is to be used between the bias supply output filter capacitance and the tube grid-No.1. The bias supply output filter capacitance is to be no greater than 150  $\mu\text{F}$ .
- m A fault current limiting resistor of no less than 320 ohms is to be used between the screen output filter capacitance and the tube screen. The screen supply output filter capacitance is to be no greater than 80  $\mu\text{F}$ .
- n The tube should see an effective plate supply impedance which limits the peak current through the tube under surge conditions to 15 amperes.

The following footnotes apply to the *RCA Transmitting Tube Operating Considerations* given at front of this section.

p See *Electrical Considerations - Filament or Heater*.

q See *Cooling Considerations - Forced-Air Cooling*.

r See *Classes of Service*.

### CHARACTERISTICS RANGE VALUES

Test No.	Note	Min	Max	
1. Heater Current . . . . .	1	1.15	1.45	A
2. Direct Interelectrode Capacitances				
Grid No.1 to plate . . . . .	2	-	0.13	pF
Grid No.1 to cathode . . . . .	2	14.3	17.7	pF
Plate to cathode . . . . .	2	0.0065	0.0155	pF
Grid No.1 to grid No.2 . . . . .	2	20.8	25.2	pF
Grid No.2 to plate . . . . .	2	5.7	7.1	pF
Grid No.2 to cathode . . . . .	2	2.0	3.0	pF
Cathode to heater . . . . .	2	2.5	4.1	pF
3. Grid-No.1 Voltage . . . . .	1,3	-8	-19	V
4. Reverse Grid-No.1 Current . . . . .	1,3	-	-25	$\mu\text{A}$
→ 5. Grid-No.2 Current . . . . .	1,3	-7	+6	mA
6. Peak Emission . . . . .	1,4	13	-	peak A
→ 7. Interelectrode Leakage Resistance	5	50	-	M $\Omega$
→ 8. Zero Bias Plate Current . . . . .	1,6	1	1.8	A

Note 1: With 13.5 volts ac or dc on heater.

Note 2: Measured with special shield adapter.

Note 3: With dc plate voltage at 700 volts, dc grid-No.2 voltage of 250 volts, and dc grid-No.1 voltage adjusted to give a dc plate current of 185 mA.

Note 4: For conditions with grid No.1, grid No.2, and plate tied together; and pulse voltage source connected between plate and cathode. Pulse duration is 2.5 microseconds and pulse repetition frequency is 60 p/s. The voltage-pulse amplitude is 200 volts peak. After 1 minute at this value, the current-pulse amplitude will not be less than the value specified.

Note 5: Under conditions with tube at 20° to 30° C for at least 30 minutes without any voltages applied to the tube. The minimum resistance between any two electrodes as measured with a 200-volt Megger-type ohmmeter having an internal impedance of 1 megohm, will be no less than the value specified.

Note 6: With dc plate voltage of 450 volts, dc grid-No.2 voltage of 400 volts, dc grid-No.1 voltage of -100 volts, grid drive voltage to zero. With pulse duration of 4500 to 5000  $\mu\text{s}$  and pulse repetition frequency is 10 to 12 p/s.

→ Indicates a change.





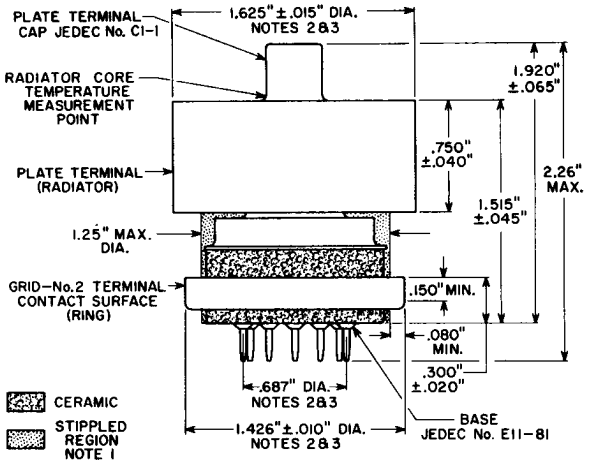

92CS-11304RI

**NOTE 1:** KEEP ALL STIPPLED REGIONS CLEAR. DO NOT ALLOW CONTACTS OR CIRCUIT COMPONENTS TO PROTRUDE INTO THESE ANNULAR VOLUMES.

**NOTE 2:** THE DIAMETERS OF THE RADIATOR, GRID-No.2 TERMINAL CONTACT SURFACE, AND PIN CIRCLE TO BE CONCENTRIC WITHIN THE FOLLOWING VALUES OF MAXIMUM FULL INDICATOR READING:

Radiator to Grid-No.2	
Terminal Contact Surface . . . . .	0.030" max.
Radiator to Pin Circle . . . . .	0.040" max.
Grid-No.2 Terminal Contact	
Surface to Pin Circle . . . . .	0.030" max.

**NOTE 3:** THE FULL INDICATOR READING IS THE MAXIMUM DEVIATION IN RADIAL POSITION OF A SURFACE WHEN THE TUBE IS COMPLETELY ROTATED ABOUT THE CENTER OF THE REFERENCE SURFACE. IT IS A MEASURE OF THE TOTAL EFFECT OF RUN-OUT AND ELLIPTICITY.



## TYPICAL COOLING REQUIREMENTS

AIR FLOW DIRECTED THROUGH RADIATOR WITH AIR CHIMNEY SK-606 (EITEL-McCULLOUGH INC.), AND SOCKET CD464-2 (MYCALEX CORP. OF AMERICA), AND BY-PASS CAPACITOR (E.F. JOHNSON CO.)  
 PLATE-CORE TEMPERATURE — 250° C.  
 INCOMING-AIR TEMPERATURE — 24° C.

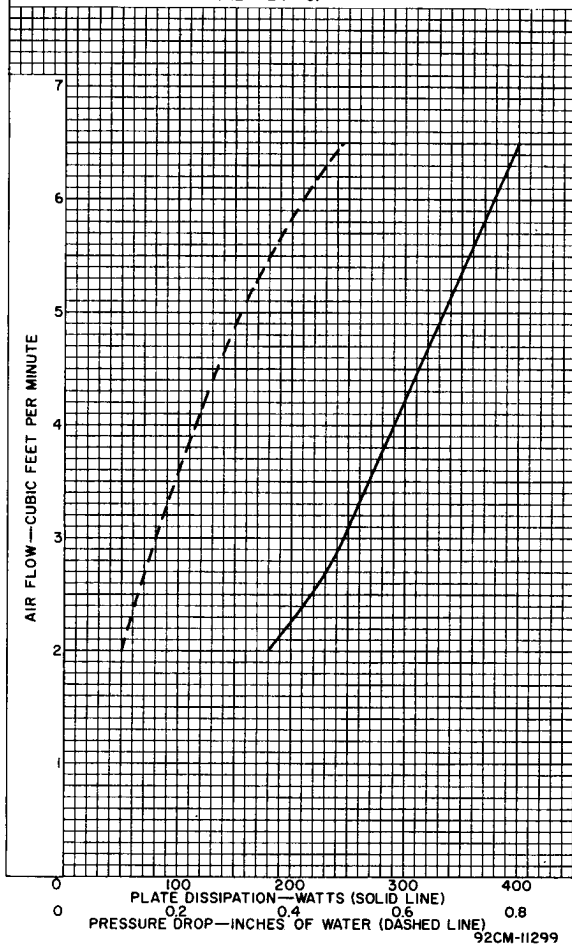

## TYPICAL PLATE CHARACTERISTICS

For Grid-No.2 Voltage = 400 Volts

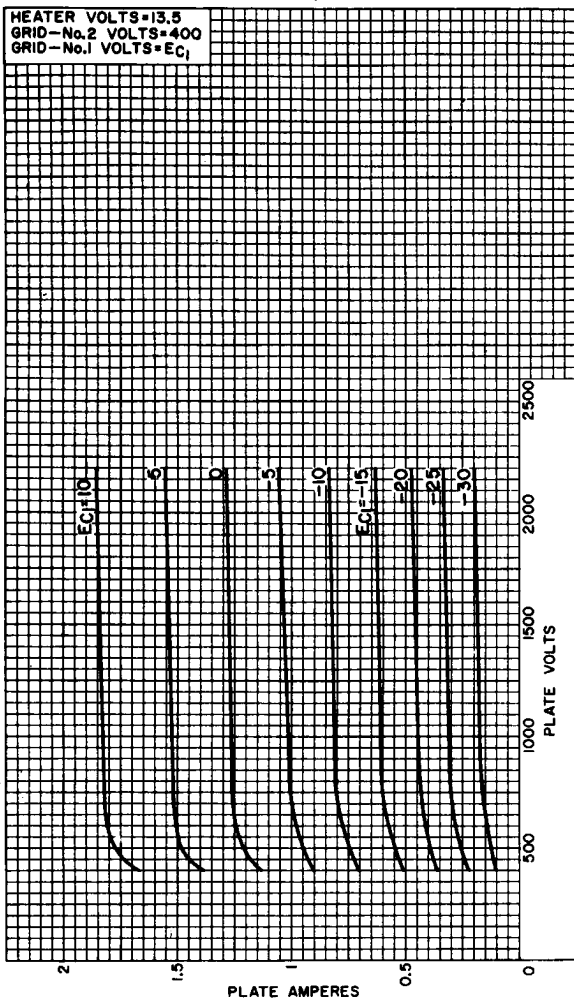

92CM-11290



RADIO CORPORATION OF AMERICA  
 Electronic Components and Devices  
 Harrison, N. J.

DATA 4  
 10-66

## TYPICAL CHARACTERISTICS

For Grid-No.2 Voltage = 400 Volts

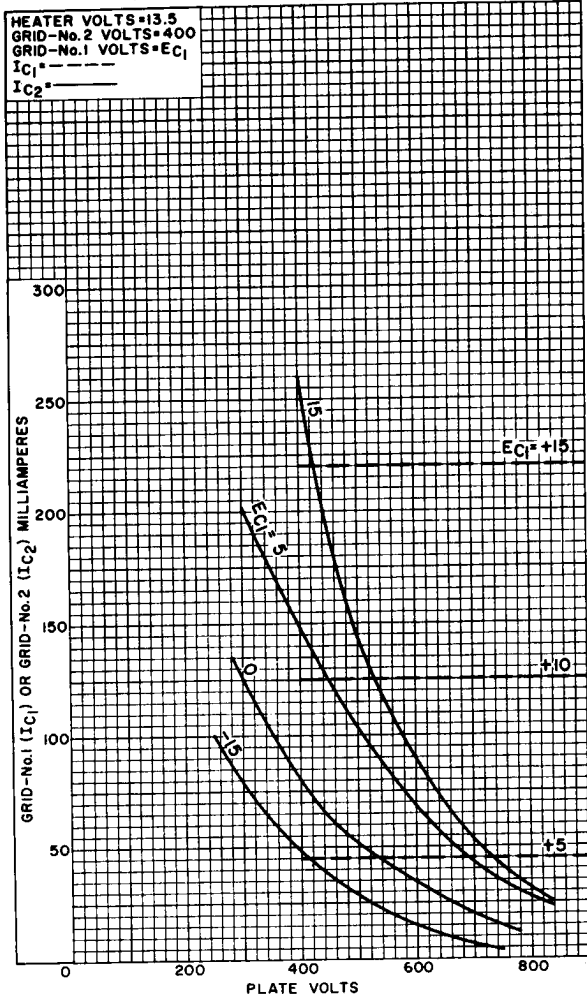

92CM-11293RI



## TYPICAL CONSTANT-CURRENT CHARACTERISTICS

For Grid-No.2 Voltage = 400 Volts

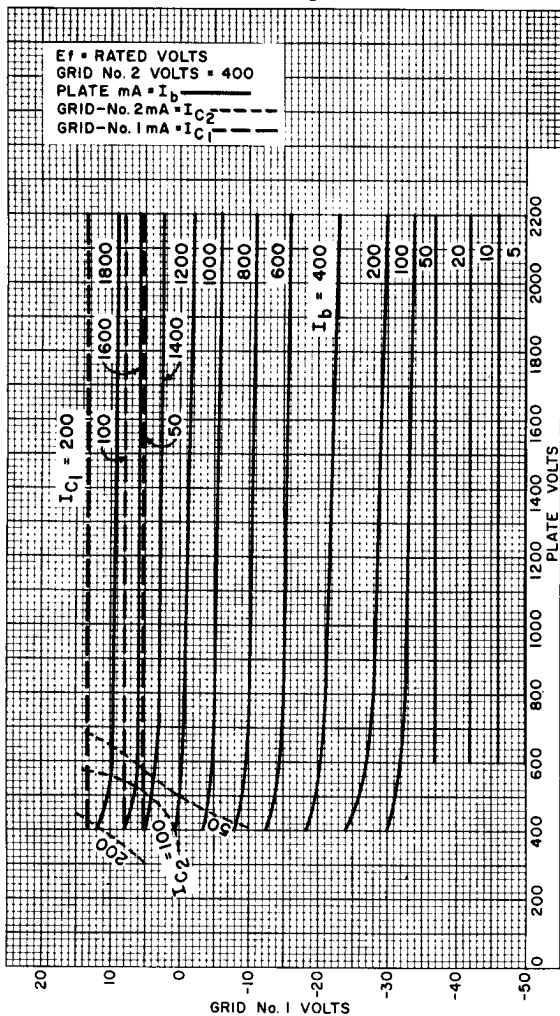

92CM-13389



## TYPICAL CONSTANT-CURRENT CHARACTERISTICS

For Grid-No.2 Voltage = 250 Volts

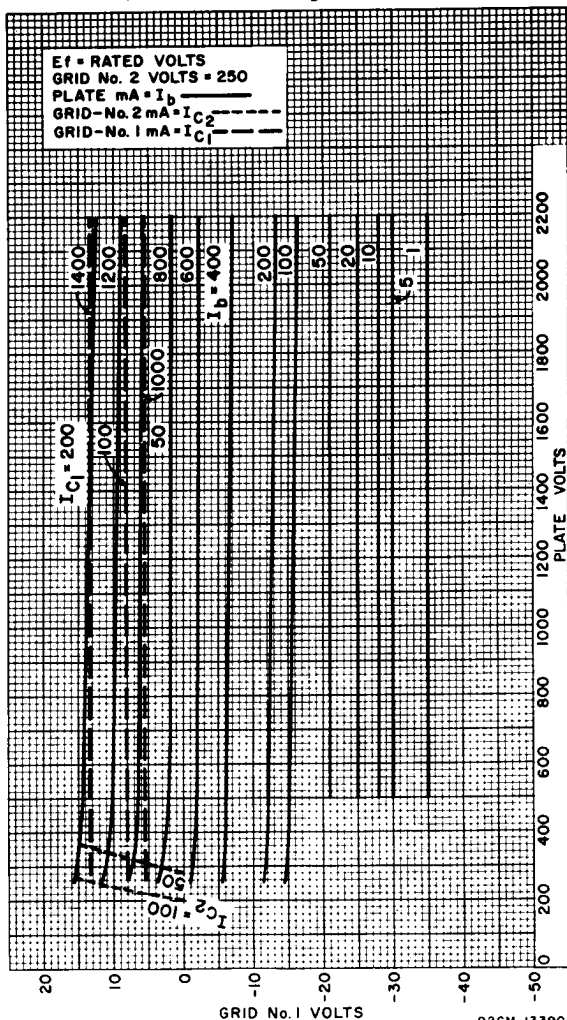

92CM-13390

