

Beam Power Tube

CERAMIC-METAL SEALS
"ONE-PIECE" ELECTRODE DESIGN

COAXIAL-ELECTRODE STRUCTURE
INTEGRAL RADIATOR

2 MEGAWATT MAXIMUM PEAK POWER INPUT UP TO 500 Mc
MATRIX-TYPE, OXIDE-COATED, UNIPOTENTIAL CATHODE

For use at Frequencies up to 500 Mc

GENERAL DATA

Electrical:

Heater, for Matrix-Type, Oxide-Coated, Unipotential Cathode^a

	<i>Typical</i>	<i>Maximum</i>	
Voltage (AC or DC)	22	23	volts
Current at heater volts = 22.	12.6		amp
Minimum heating time.	5		minutes
Mu-Factor, Grid No.2 to Grid No.1 for plate volts = 5000; grid-No.2 volts = 1400, and plate ma. = 500	25		
Direct Interelectrode Capacitances:			
Grid No.1 to plate ^b	0.3 max.		pf
Grid No.1 to cathode & heater	100		pf
Plate to cathode & heater ^{b, c}	0.03 max.		pf
Grid No.1 to grid No.2.	110		pf
Grid No.2 to plate.	24		pf
Grid No.2 to cathode & heater ^c	1.5 max.		pf

Mechanical:

Operating Position. Any
 Maximum Overall Length. 7.24"
 Maximum Diameter. 5.56"
 Weight (Approx.). 8.5 lbs
 Radiator. Integral part of tube
 Terminal Connections (See *Dimensional Outline*):

G₁ - Grid-No-1-
Terminal
Contact
Surface
 G₂ - Grid-No.2-
Terminal
Contact
Surface
 H - Heater-
Terminal
Contact
Surface

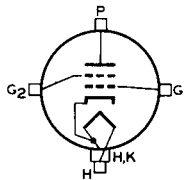

H, K - Heater- &
Cathode-
Terminal
Contact
Surface
 P - Plate-
Terminal
Contact
Surface

Thermal:

Air Flow:

Through radiator—Adequate air flow to limit the plate-core temperature to 250° C should be delivered by a blower through the radiator before and during the application of heater, plate, grid-No.2, and grid-No.1 voltages. Typical



values of air flow directed through the radiator versus plate dissipation are shown in accompanying *Typical-Cooling-Requirements* curve.

To Plate, Grid-No.2, Grid-No.1, Cathode, and Heater Terminals-

A sufficient quantity of air should be allowed to flow past each of these terminals to prevent their temperature from exceeding the specified maximum value of 250° C.

Plate power, grid-No.2 power, heater power, and the forced-air flow may be removed simultaneously.

Terminal Temperature^d (Plate, grid No.2,

grid No.1, cathode, and heater) 250 max. °C

Plate Core Temperature^d 250 max. °C

PULSED RF AMPLIFIER

Maximum CCS^e Ratings, Absolute-Maximum Values:

For maximum "on" time^f of 10 microseconds in any 2000-microsecond interval and frequencies up to 500 Mc

PEAK POSITIVE PULSE PLATE VOLTAGE ^g	25000 max.	volts
DC PLATE VOLTAGE ^g	15000 max.	volts
POSITIVE-PULSE GRID-No.2 VOLTAGE:		
Peak	2500 max.	volts
DC	2500 max.	volts
NEGATIVE-PULSE GRID-No.1 VOLTAGE:		
Peak	500 max.	volts
DC	500 max.	volts
DC-PULSE PLATE CURRENT	80 max.	amps
DC PLATE CURRENT	0.5 max.	amp
GRID-No.2 INPUT (Average)	150 max.	watts
GRID-No.1 INPUT (Average)	100 max.	watts
PLATE DISSIPATION (Average)	10000 max.	watts

Maximum Circuit Values:

Grid-No.1-Circuit Resistance		
under any condition	2000 max.	ohms

^a See *Operating Considerations*.

^b with external flat metal shield 8" diameter having center hole 4" diameter. Shield is located in plane of the grid-No.2 terminal, perpendicular to the tube axis, and is connected to grid No.2 and ground.

^c with external flat metal shield 8" diameter having center hole 3-3/8" diameter. Shield is located in plane of the grid-No.1 terminal, perpendicular to the tube axis, and is connected to grid No.1 and ground.

^d See *Operating Considerations* and also *Dimensional Outline* for temperature-measurement points.

^e Continuous Commercial Service.

^f "On" time is defined as the sum of the durations of all the individual pulses which occur during the interval. An increase in dc plate current during the pulse may be permissible at shorter "on" times, and a decrease is usually required at longer "on" times. *Pulse duration* is defined as the time interval between the two points on the pulse at which the instantaneous value is 70 per cent of the peak value. *Peak value* is defined as the maximum value of a smooth curve through the average of the fluctuations over the top portion of the pulse. *Duty factor* is defined as the ratio of "on" time to total elapsed time in any interval.

^g Pressurization may be required when the tube is used at high altitudes and plate voltages near the maximum rating to prevent flash-over at the tube seals.

CHARACTERISTICS RANGE VALUES

	Note	Min.	Max.	
Heater Current.	1	11.7	13.5	amp
Direct Interelectrode Capacitances:				
Grid No.1 to plate.	2	-	0.3	pf
Grid No.1 to cathode & heater . . .		91	113	pf
Plate to cathode & heater	2,3	-	0.03	pf
Grid No.1 to grid No.2.		99	121	pf
Grid No.2 to plate.		21	26	pf
Grid No.2 to cathode & heater . . .	3	-	1.5	pf
Grid-No.1 Voltage	1,4	-27	-61	volts
Grid-No.1 Cutoff Voltage.	1,5	-	-95	volts

Note 1: With 22 volts ac or dc on heater.

Note 2: With external flat metal shield 8" diameter having center hole 4" diameter. Shield is located in plane of the grid-No.2 terminal, perpendicular to the tube axis, and is connected to grid No.2 and ground.

Note 3: With external flat metal shield 8" diameter having center hole 3-3/8" diameter. Shield is located in plane of the grid-No.1 terminal, perpendicular to the tube axis, and is connected to grid No.1 and ground.

Note 4: With dc plate voltage of 5000 volts, dc grid-No.2 voltage of 1500 volts, and dc grid-No.1 voltage adjusted to give a plate current of 500 ma.

Note 5: With dc plate voltage of 5000 volts, dc grid-No.2 voltage of 1500 volts, and dc grid-No.1 voltage adjusted to give a plate current of 20 ma.

OPERATING CONSIDERATIONS

Heater

The heater of the 8184 should be operated at constant voltage rather than constant current. The rated heater voltage of 22 volts should be applied for 5 minutes to allow the cathode to reach normal operating temperature before voltages are applied to the other electrodes. Good regulation of the heater voltage is in general economically advantageous from the viewpoint of tube life; in no case should the voltage fluctuations be more than 5%.

Temperature

The maximum terminal temperature of 250° C is a tube rating and is to be observed in the same manner as other ratings. The temperature may be measured with temperature-sensitive paint, such as Tempilaq. The latter is made in the form of liquid and stick by the Tempil Corporation, 132 West 22nd Street, New York 11, N.Y.

Standby Operation

During long or frequent standby periods, the 8184 may be operated at decreased heater voltage to conserve life. It is recommended that the heater voltage be reduced to 80% of normal during standby periods up to 2 hours. For longer periods, the heater voltage should be turned off.



Precautions

The maximum-rated plate and grid-No.2 voltages of this tube are extremely dangerous. Great care should be taken during the adjustment of circuits. The tube and its associated apparatus, especially all parts which may be at high potential above ground, should be housed in a protective enclosure. The protective housing should be designed with interlocks so that personnel can not possibly come in contact with any high-potential point in the electrical system. The interlock devices should function to break the primary circuit of the high-voltage supplies when any gate or door on the protective housing is opened, and should prevent the closing of the primary circuit until the door is again locked.

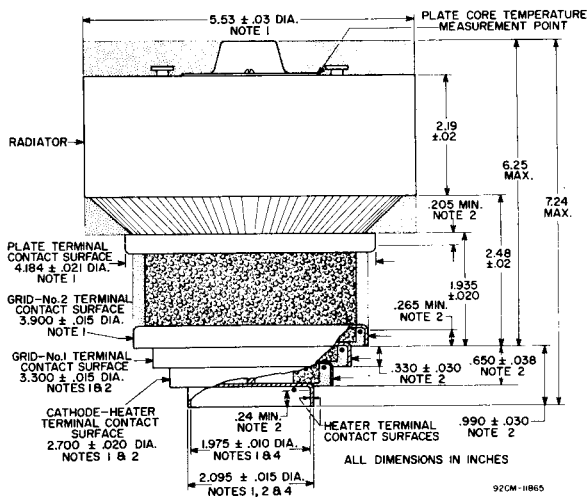

STIPPLED REGION
NOTE 3

CERAMIC INSULATOR

• TERMINAL TEMPERATURE
MEASUREMENT POINT

NOTE 1: SEE SKETCH G1 FOR THE MAXIMUM DIAMETRICAL SPACE REQUIRED BY THE 8184 BASED UPON THE DIAMETER AND ECCENTRICITY OF RADIATOR BAND AND OF EACH RING TERMINAL.

NOTE 2: THE DIAMETER OF THE TERMINAL IS HELD TO THE INDICATED VALUE ONLY OVER THE CONTACT SURFACE LENGTH. THE CONTACT SURFACE LENGTH OF THE HEATER, HEATER-CATHODE, AND GRID-No.1 TERMINALS EXTENDS FROM THE EDGE OF ITS TERMINAL TO THE PLANE COINCIDENT WITH THE EDGE OF THE ADJACENT LARGER TERMINAL.

NOTE 3: KEEP ALL STIPPLED REGIONS CLEAR. DO NOT ALLOW CONTACTS OR CIRCUIT COMPONENTS TO PROTRUDE INTO THESE ANNULAR REGIONS.

NOTE 4: THE HEATER TERMINAL IS DIMENSIONED FOR INSIDE DIAMETER AND OUTSIDE DIAMETER TO PROVIDE A CHOICE OF CONTACT MOUNTING; THE DIMENSIONS SHALL NOT BE CONSIDERED CONCURRENTLY.

SKETCH 61

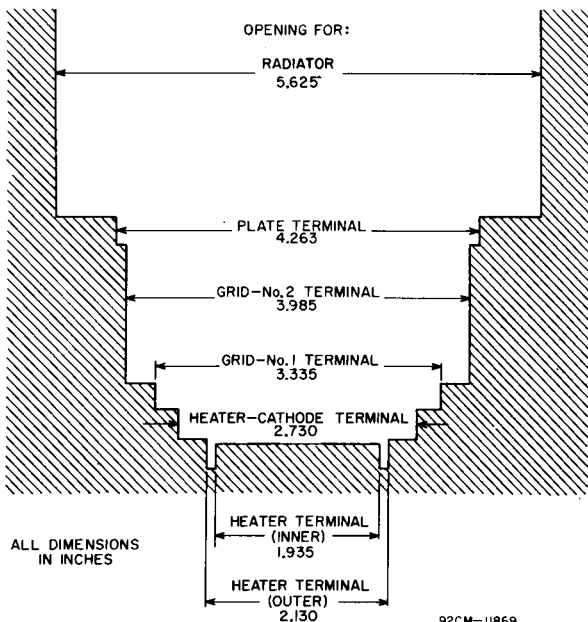

SUGGESTED MOUNTING ARRANGEMENT
& LAYOUT OF ASSOCIATED CONTACTS

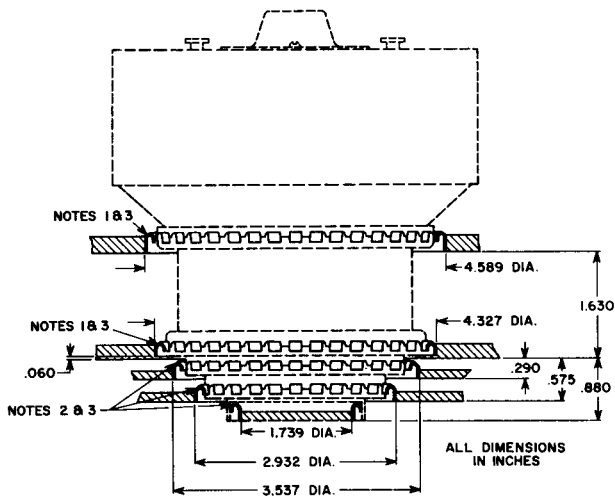

92CM-11966

NOTE 1: FINGER STOCK NO.97-310.

NOTE 2: FINGER STOCK NO.97-139.

NOTE 3: SPECIFIED FINGER STOCK IS MADE BY INSTRUMENT SPECIALITIES COMPANY, LITTLE FALLS, NEW JERSEY.

TYPICAL COOLING REQUIREMENTS

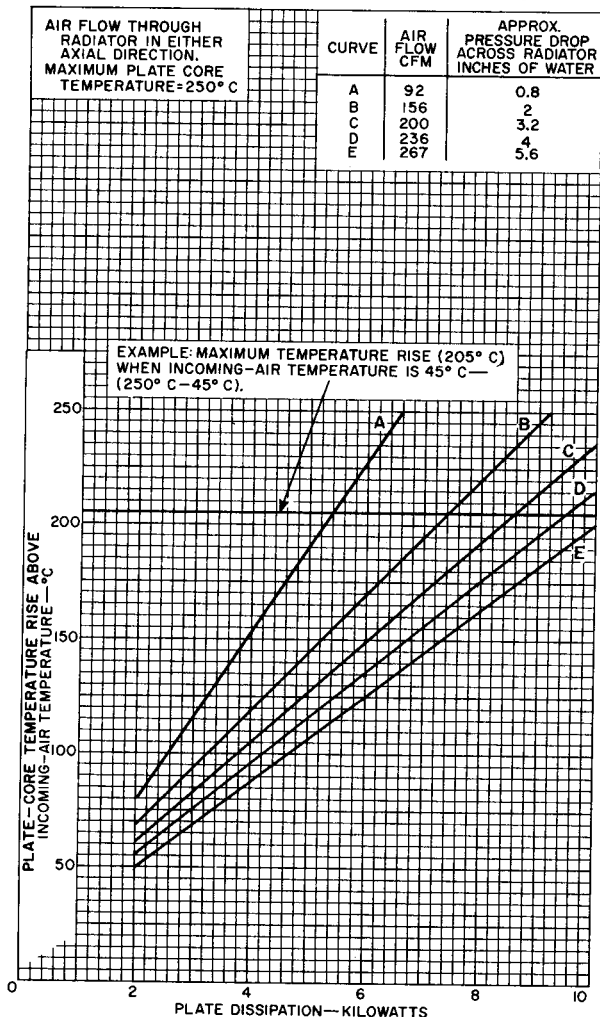

92CM-11861



TYPICAL PLATE CHARACTERISTICS

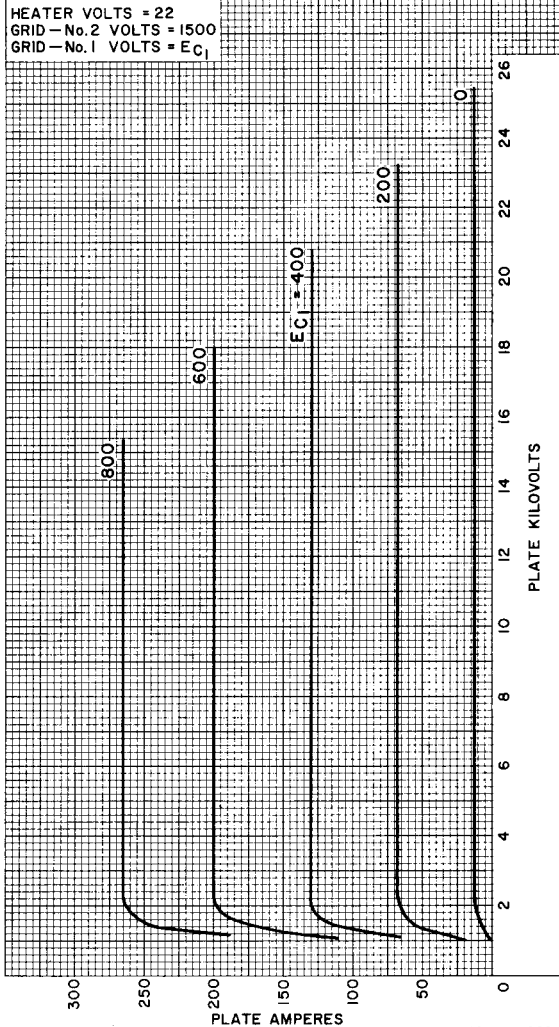

92CM-11862



TYPICAL CHARACTERISTICS

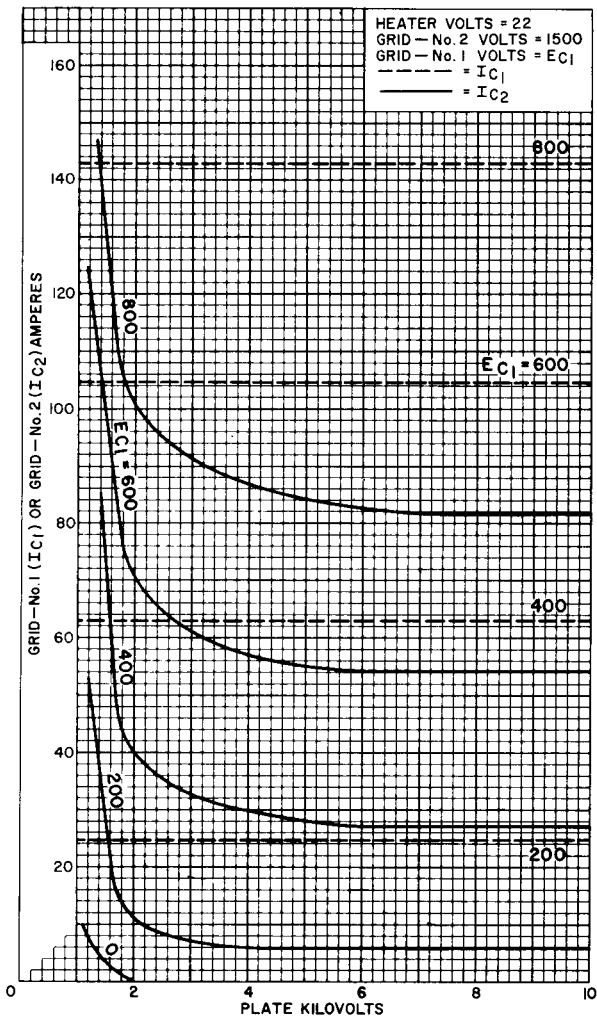

92CM-11864

