

Vidicon

MAGNETIC FOCUS 1-1/2" Diameter MAGNETIC DEFLECTION

For Black-and-White Pickup in Industrial
Closed-Circuit TV Systems Requiring Limiting
Resolutions of more than 1200 TV Lines

General:

Heater, for Unipotential Cathode:

Voltage (AC or DC) $6.3 \pm 10\%$ volts
Current at heater volts = 6.3 0.6 amp

Direct Interelectrode Capacitance:^a

Target to all other electrodes 8.0 pf

Spectral Response See Accompanying Curve

Photoconductive Layer:

Maximum useful diagonal of rectangular image (4 x 3 aspect ratio)^b 1"

Focusing Method Magnetic

Deflection Method Magnetic

Overall Length 7.75 ± 0.25 "Greatest Diameter 1.59 ± 0.01 "Bulb Diameter 1.50 ± 0.01 "

Operating Position Any

Weight (Approx.) 5.25 oz

Bulb T12

Focusing-Alignment Assembly Cleveland Electronics^c

No. 15-VFA-259, or equivalent

Deflecting Yoke^d Cleveland Electronics^c

No. 15-VY-258, or equivalent

Socket Alden^e No. 208-SBSDC, or equivalent

Base Small-Button Super-Ditetra 8-Pin (JEDEC No. E8-78)

Basing Designation for BOTTOM VIEW 8LB

Pin 1 - Heater
Pin 2 - Grid No.1
Pin 3 - Do Not Use
Pin 4 - Grid No.4
Pin 5 - Grid No.2
Pin 6 - Grid No.3
Pin 7 - Cathode
Pin 8 - Heater
Flange - Target
Short Index Pin - Do Not Use

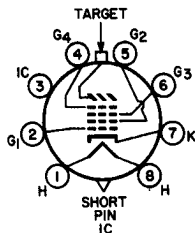

DIRECTION OF LIGHT:
INTO FACE END OF TUBE

Maximum Ratings, Absolute-Maximum Values:

For scanned area of 0.6" x 0.8"

Grid-No.4 Voltage 1500 max. volts
Grid-No.3 Voltage 1500 max. volts
Grid-No.2 Voltage 550 max. volts



Grid-No.1 Voltage:		
Negative-bias value.	300 max.	volts
Positive-bias value.	0 max.	volts
Peak Heater-Cathode Voltage:		
Heater negative with respect to cathode .	125 max.	volts
Heater positive with respect to cathode .	10 max.	volts
Target Voltage	100 max.	volts
Dark Current	0.25 max.	μ a
Peak Target Current ^f	0.60 max.	μ a
Faceplate:		
Illumination	1000 max.	fc
Temperature.	71 max.	$^{\circ}$ C

Typical Operation:

*For scanned area of 0.6" x 0.8" and
faceplate temperature of 28 $^{\circ}$ to 34 $^{\circ}$ C*

Grid-No.4 (Decelerator) Voltage ^g	1400	volts
Grid-No.3 (Beam-Focus Electrode ^h).	800 to 1000	volts
Grid-No.2 (Accelerator) Voltage.	300	volts
Grid-No.1 Voltage for picture cutoff ^j	-45 to -100	volts
Average "Gamma" of Transfer Characteristic for signal-output current between 0.02 μ a and 0.6 μ a		
	0.65	
Minimum Peak-to-Peak Blanking Voltage:		
When applied to grid No.1.	75	volts
When applied to cathode.	20	volts
Lag—Per Cent of Initial Value of Signal- Output Current 1/20 Second after Illumination is Removed: ^k		
Maximum value.	45	%
Typical value.	30	%
Limiting Resolution:		
At center of picture—		
Typical value.	1500	TV lines
Minimum value.	1200	TV lines
At corners of picture—		
Typical value.	900	TV lines
Amplitude Response to a 400 TV Line Square-Wave Test Pattern at Center of Picture:		
Minimum value.	60	%
Field Strength at Center of Focusing Coil (Approx.).		
	46	gauss
Field Strength of Adjustable Alignment Coil ^m		
	0 to 4	gauss
Peak Deflecting-Coil Current for Specified Deflecting Yoke:		
Horizontal	240	ma
Vertical	50	ma
<i>Maximum-Sensitivity Operation— 0.1 Footcandle on Faceplate</i>		
Faceplate Illumination (Highlight).		
	0.1	tc

Target Voltage ^{n, p}	30 to 60	volts
Dark Current ^q	0.1	μ a
Signal-Output Current: ^r		
Typical	0.2	μ a

*Average-Sensitivity Operation—
1.0 Footcandle on Faceplate*

Faceplate Illumination (Highlight)	1.0	fc
Target Voltage ^{n, p}	17 to 35	volts
Dark Current ^q	0.02	μ a
Signal-Output Current: ^r		
Typical	0.20	μ a
Minimum	0.15	μ a

*High-Light Level Operation—
10 Footcandles on Faceplate*

Faceplate Illumination (Highlight)	10	fc
Target Voltage ^{n, p}	10 to 20	volts
Dark Current ^q	0.005	μ a
Signal-Output Current: ^r		
Typical	0.3	μ a

- ^a This capacitance, which effectively is the output impedance of the 8521, is increased when the tube is mounted in the deflecting-yoke and focusing-alignment assembly. The resistive component of the output impedance is in the order of 100 megohms.
- ^b Proper orientation of quality rectangle is obtained when the horizontal scan is essentially parallel to the plane passing through the axis and short index pin. The masking is for orientation only and does not define the proper scanned area of photoconductive layer. Final orientation should be such that the image also fits inside of any internal mask of the mesh assembly.
- ^c Cleveland Electronics Inc., 1974 East 61st St., Cleveland, Ohio.
- ^d For minimum geometric distortion, the deflecting yoke should be located in its proper axial position 3/4-inch from the face of the tube.
- ^e Alden Products Co., 9140 North Main Street, Brockton 64, Mass.
- ^f Video amplifiers must be designed properly to handle target currents of this magnitude to avoid amplifier overload or picture distortion.
- ^g Grid-No.4 voltage must always be greater than grid-No.3 voltage. For minimum "porthole" effect, grid-No.4 voltage should be adjusted to approximately 1.6 times the grid-No.3 voltage value, and the focusing-alignment assembly and deflecting yoke positioned as shown in accompanying diagram.
- ^h Beam focus is obtained by the combined effect of grid-No.3 voltage, which should be adjustable over indicated range, and a focusing coil having an average field strength of 46 gauss.
- ^j With no blanking voltage on grid No.1.
- ^k For initial signal-output current of 0.2 μ a and a dark current of 0.02 μ a.
- ^m The alignment coil should be located on the tube so that its center is at a distance of 6 inches from the face of the tube, and be positioned so that its axis is coincident with the axis of the tube, the deflecting yoke, and the focusing coil.
- ⁿ Indicated range for each type of service serves only to illustrate the operating target-voltage range normally encountered.
- ^p The target voltage for each 8521 must be adjusted to that value which gives the desired operating dark current.
- ^q The deflecting circuits must provide extremely linear scanning for good black-level reproduction. Dark-current signal is proportional to the scanning velocity. Any change in scanning velocity produces a black-level error in direct proportion to the change in scanning velocity.
- ^r Defined as the component of the highlight target current after the dark-current component has been subtracted.



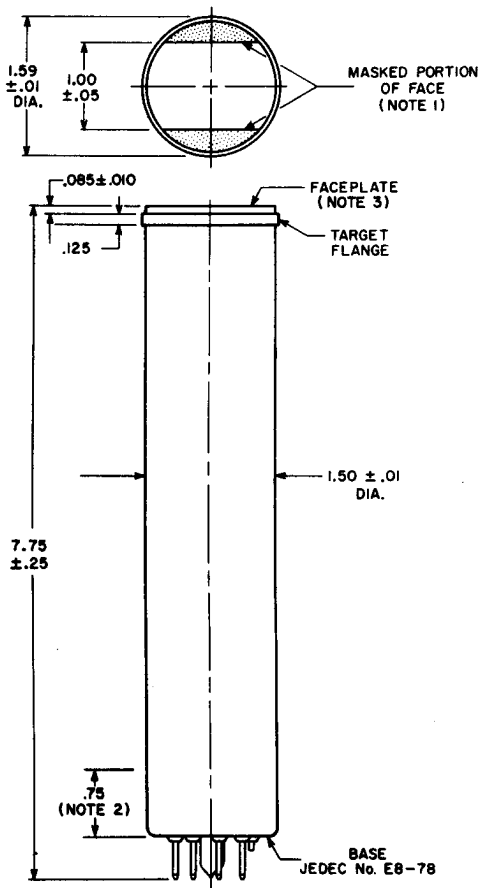

92CS-12423

DIMENSIONS IN INCHES

Note 1: Straight sides of masked portions are parallel to the plane passing through tube axis and short index pin.

Note 2: Within this area the minimum bulb diameter dimension does not apply.

Note 3: Faceplate thickness is 0.135 ± 0.005 ".

COMPONENT LOCATIONS

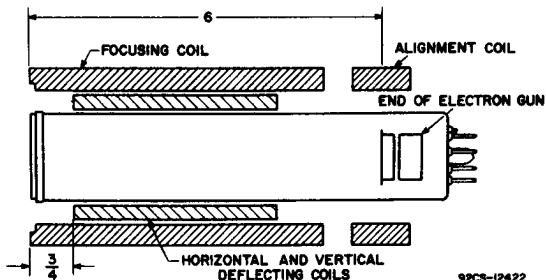

92CS-12422

DIMENSIONS IN INCHES

RANGE OF DARK CURRENT

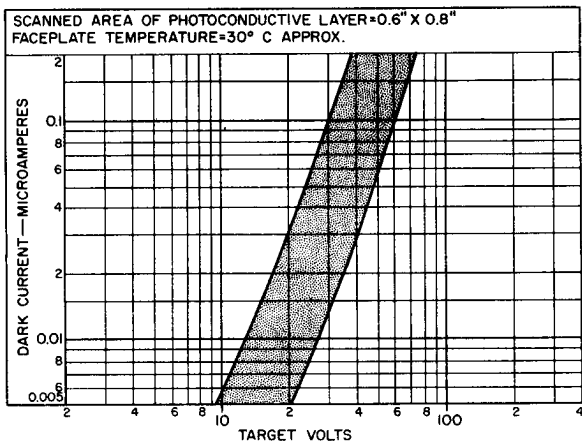

92CS-12409



LIGHT TRANSFER CHARACTERISTICS

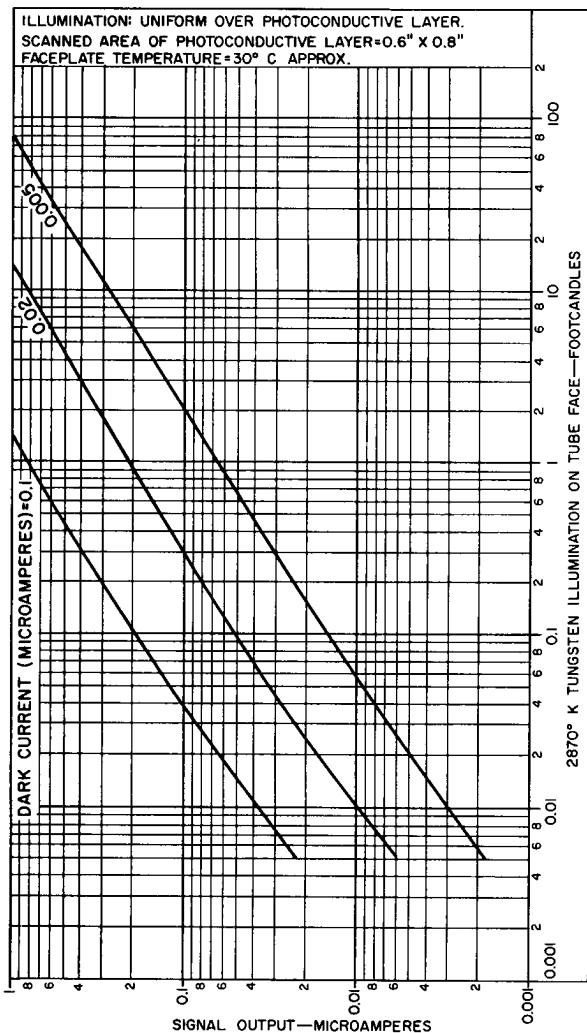

92CM-12413



TYPICAL SPECTRAL SENSITIVITY CHARACTERISTIC

FOR EQUAL VALUES OF SIGNAL-OUTPUT
CURRENT AT ALL WAVELENGTHS.
SIGNAL-OUTPUT MICROAMPERES FROM
SCANNED AREA OF $1/2" \times 3/8" = 0.02$
DARK CURRENT (MICROAMPERES) = 0.02

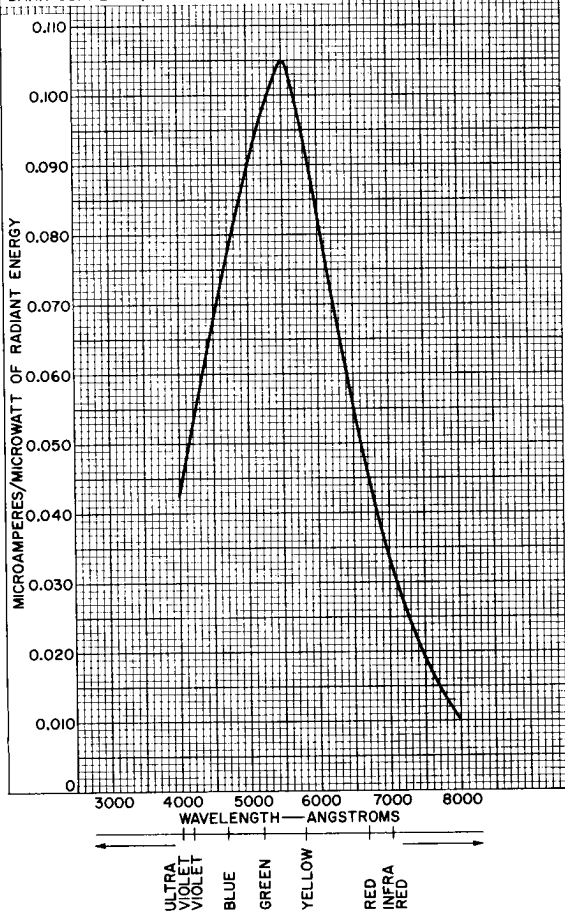

92CM-11619



RADIO CORPORATION OF AMERICA
Electronic Components and Devices

Harrison, N. J.

DATA 4
6-64

TYPICAL PERSISTENCE CHARACTERISTICS

INITIAL HIGHLIGHT SIGNAL-OUTPUT MICROAMPERES=0.2
 SCANNED AREA OF PHOTOCONDUCTIVE LAYER=0.6" X 0.8"
 FACEPLATE TEMPERATURE=30° C APPROX.

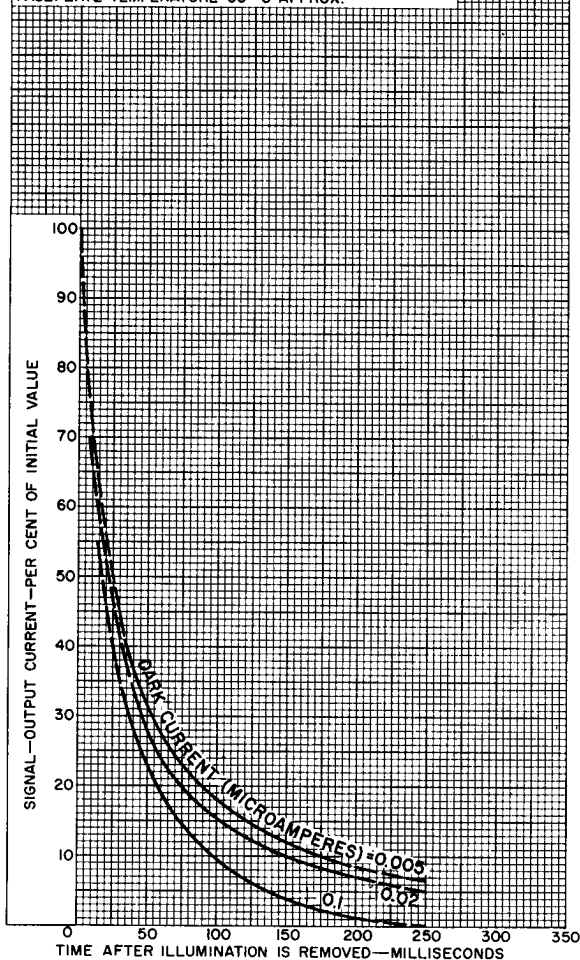

92CM-12416



UNCOMPENSATED HORIZONTAL RESPONSE TO A SQUARE-WAVE TEST PATTERN

HIGHLIGHT TARGET MICROAMPERES=0.3
 DARK CURRENT (MICROAMPERES)=0.02
 TEST PATTERN: TRANSPARENT SQUARE-
 WAVE RESOLUTION WEDGE,
 GRID-No. 4 VOLTS=1400
 GRID-No. 3 VOLTS=850
 GRID-No. 2 VOLTS=300

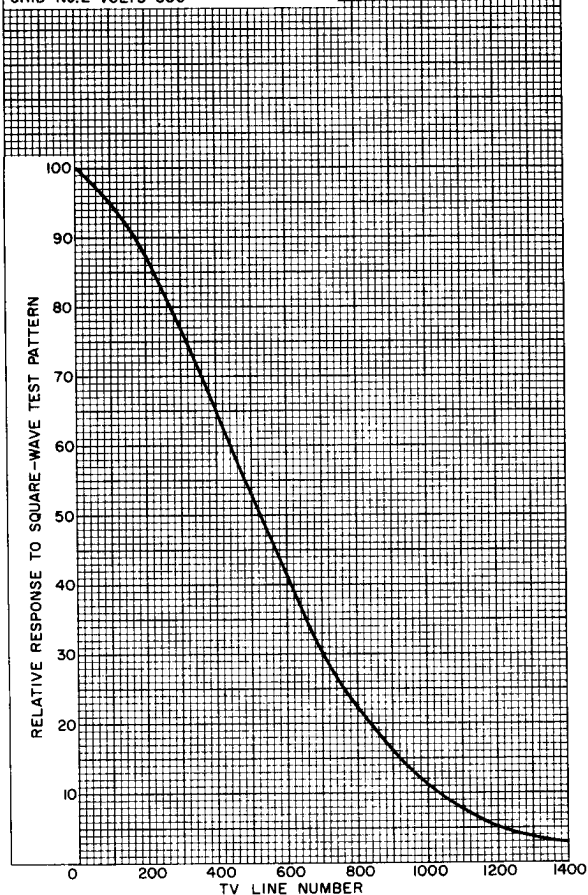

92CM-12418R1

