

**TRIODE  
 POWER AMPLIFIER**

*Western Electric*

**DESCRIPTION**

The 300B is a filamentary type triode designed for use as an audio-frequency power amplifier.

**CHARACTERISTICS**

Filament Voltage . . . . .	5.0 volts
Plate Current . . . . .	60 milliamperes
Power Output . . . . .	8 watts

$\left. \begin{array}{l} E_b = 350 \text{ volts;} \\ E_c = -74 \text{ volts} \end{array} \right\} . . . . .$

**GENERAL CHARACTERISTICS****ELECTRICAL DATA**

Filament Voltage, A-C or D-C . . . . .	5.0 volts
Filament Current . . . . .	1.2 amperes
<b>Direct Interelectrode Capacitances</b>	
Grid to Plate . . . . .	15 uuf
Input . . . . .	8.5 uuf
Output . . . . .	4.1 uuf

**MECHANICAL DATA**

Cathode . . . . .	Coated Filament
Base . . . . .	Medium 4-pin with skew bayonet pin
Mounting Position . . . . .	Preferably vertical; if horizontal, pins #1 and #2 must be in same vertical plane

Dimensions and pin connections shown in outline drawing on Page 6

**MAXIMUM RATINGS, Design-Center Values**

Plate Voltage . . . . .	400 volts
Plate Current . . . . .	100 milliamperes
Plate Dissipation . . . . .	36 watts

**Maximum Grid Circuit Resistance for**

Fixed Bias . . . . .	0.05 megohm
Self Bias . . . . .	0.25 megohm

**TYPICAL OPERATING CONDITIONS AND CHARACTERISTICS****SINGLE TUBE AMPLIFIER — CLASS A<sub>1</sub>**

Filament Voltage, A-C . . . . .	5.0	5.0 volts
Plate Voltage . . . . .	300	350 volts
Grid Voltage . . . . .	-61	-74 volts
Peak A-F Signal Voltage . . . . .	61	74 volts
Zero Signal Plate Current . . . . .	62	60 milliamperes
Maximum Signal Plate Current . . . . .	74	77 milliamperes
Transconductance . . . . .	5300	5000 micromhos
Plate Resistance . . . . .	740	790 ohms
Load Resistance . . . . .	3000	4000 ohms
Amplification Factor . . . . .	3.9	3.9
Maximum Signal Power Output . . . . .	6	7 watts
Total Harmonic Distortion . . . . .	5	5 per cent

**PUSH-PULL AMPLIFIER — CLASS A<sub>1</sub>**

Unless otherwise specified, values are for 2 tubes

Filament Voltage, A-C . . . . .	5.0	5.0 volts
Plate Voltage . . . . .	300	350 volts
Grid Voltage* . . . . .	-61	-67.5 volts
Peak A-F Grid-to-Grid Voltage . . . . .	122	135 volts
Zero Signal Plate Current . . . . .	100	170 milliamperes
Maximum Signal Plate Current . . . . .	150	200 milliamperes
Effective Load Resistance (Plate-to-Plate) . . . . .	4000	4000 ohms
Maximum Signal Power Output . . . . .	10	20 watts
Total Harmonic Distortion . . . . .	4.5	2 per cent

\*If the filament is operated on D.C., the characteristics will be approximately the same if the grid voltage, measured from the negative filament, is decreased by 2.5 volts.

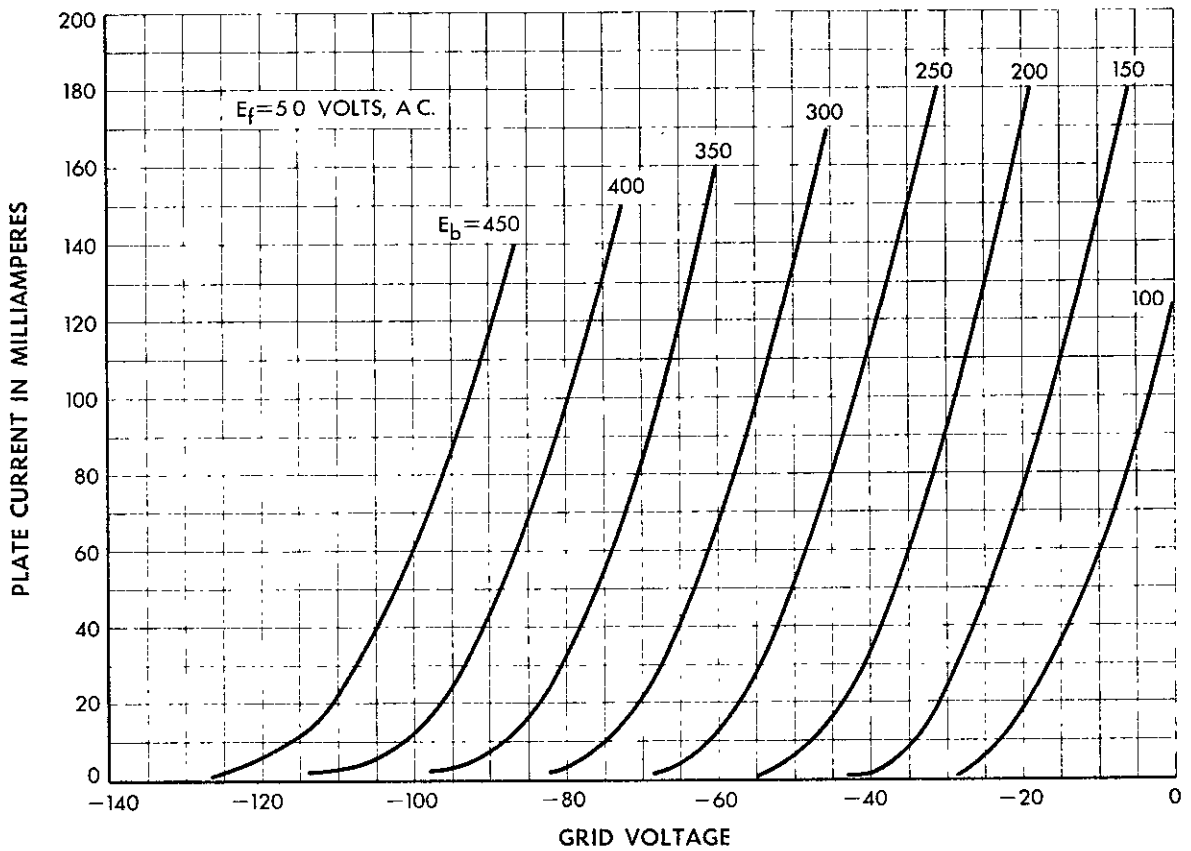
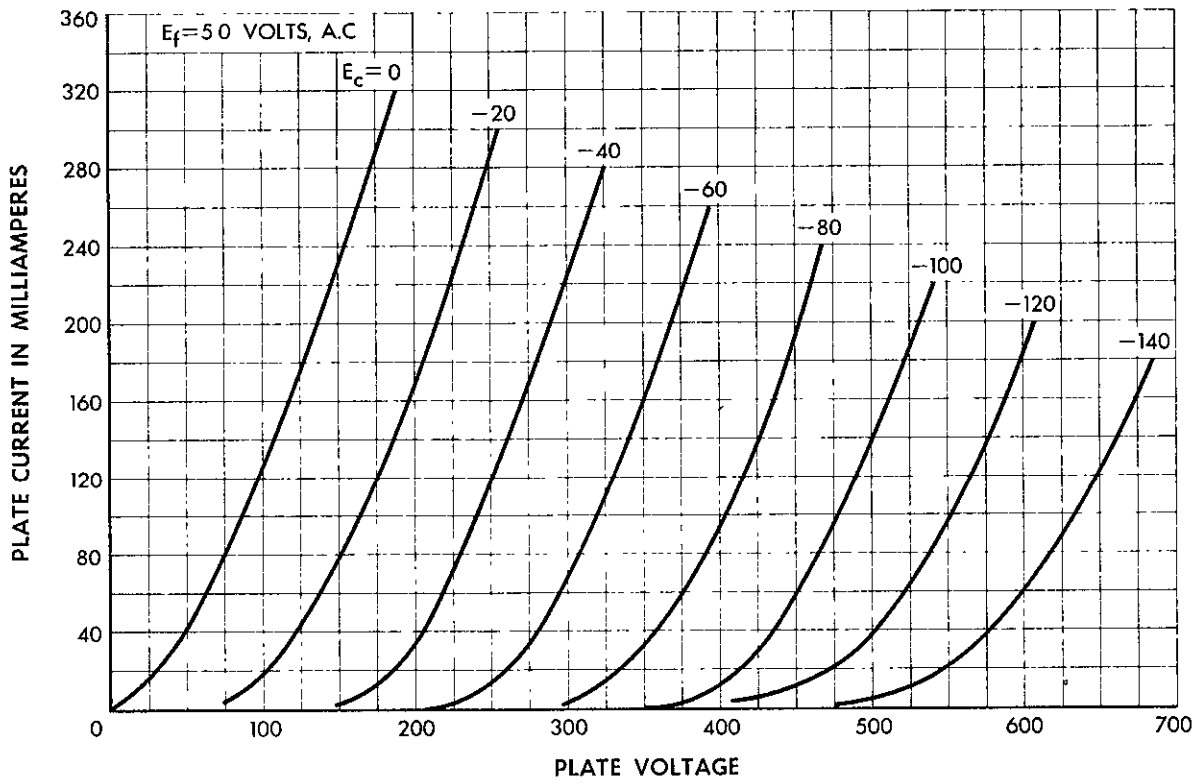

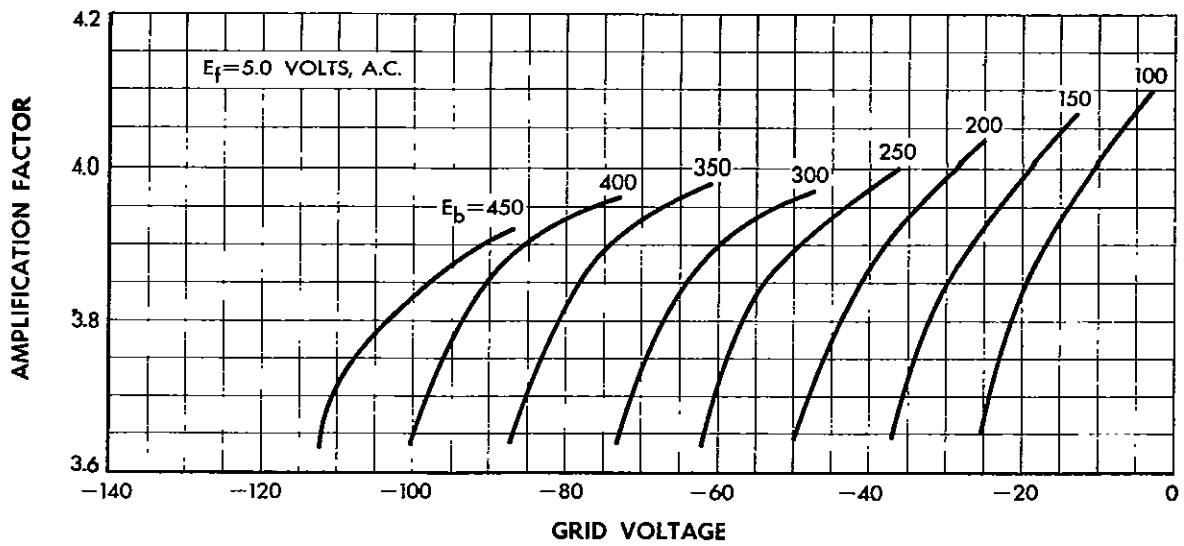
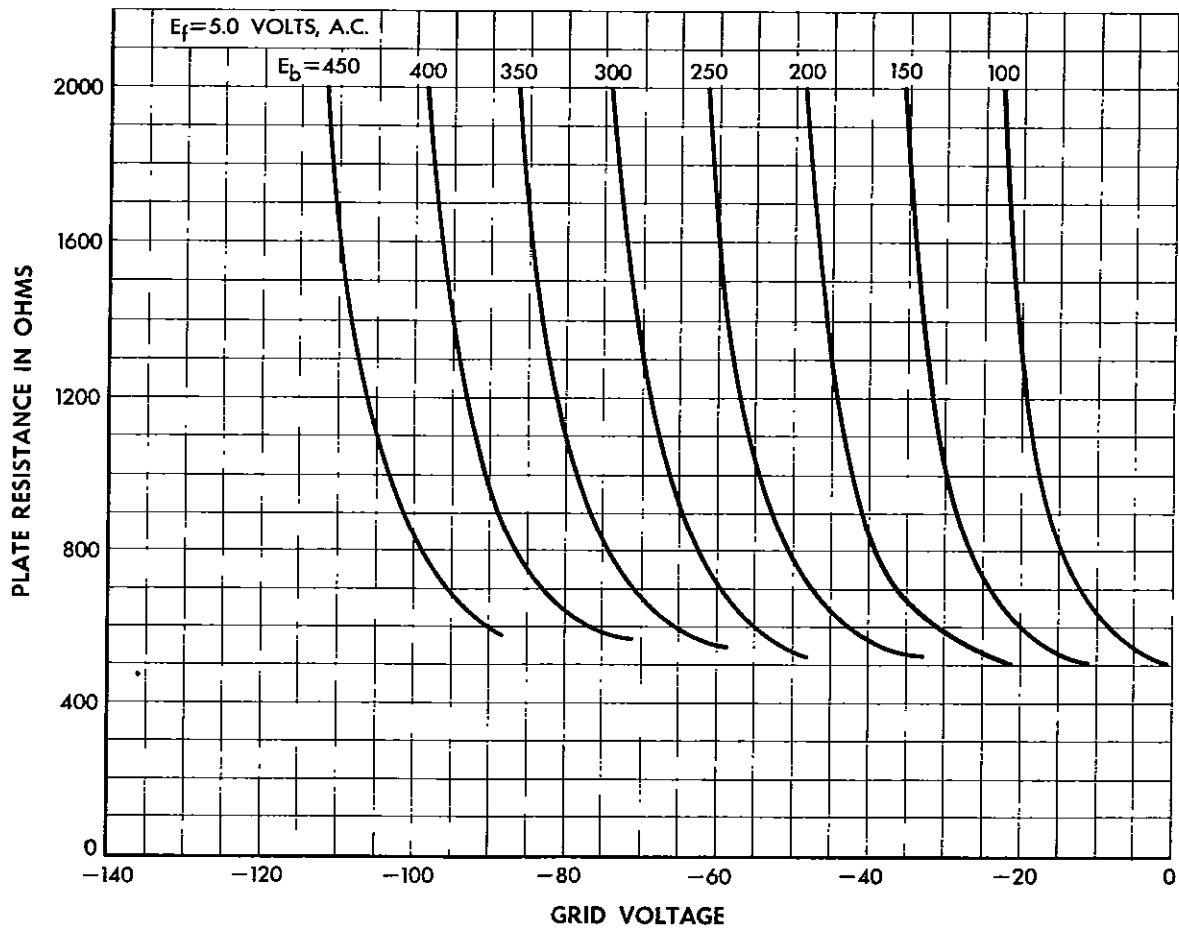

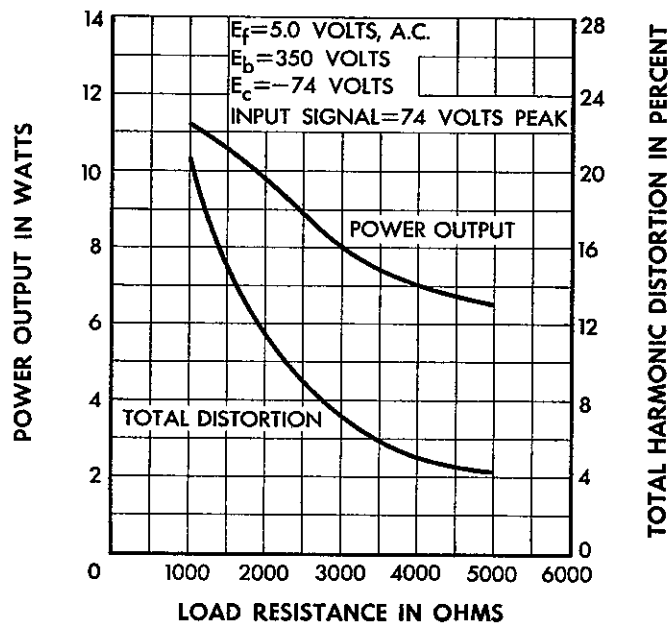
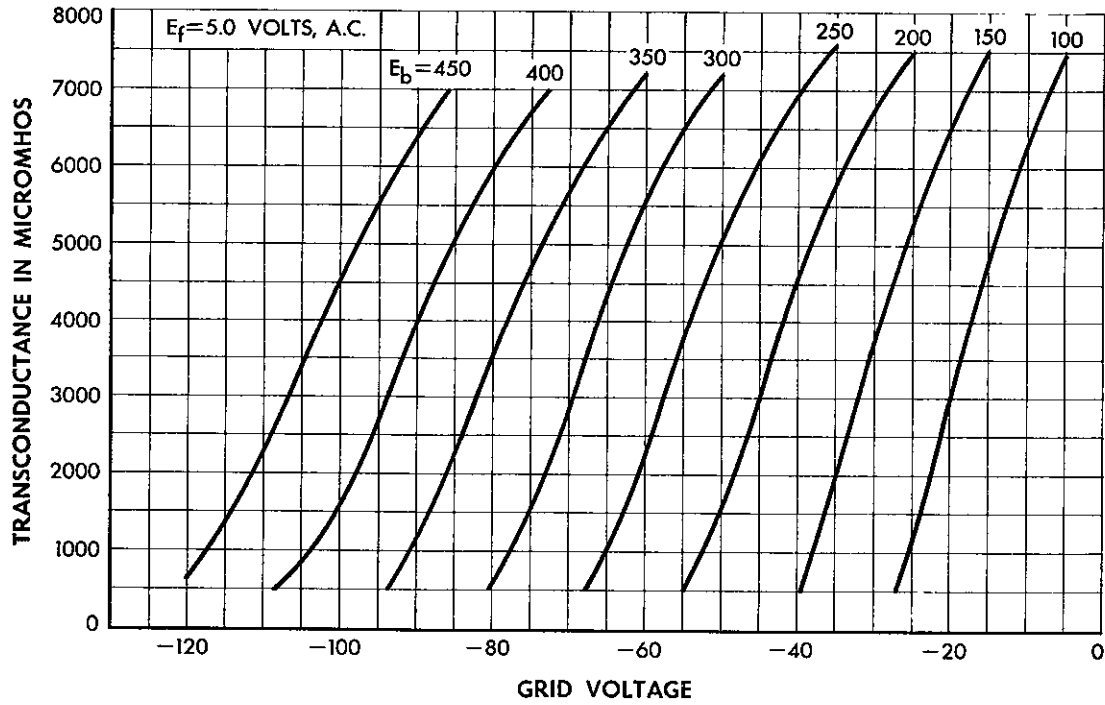

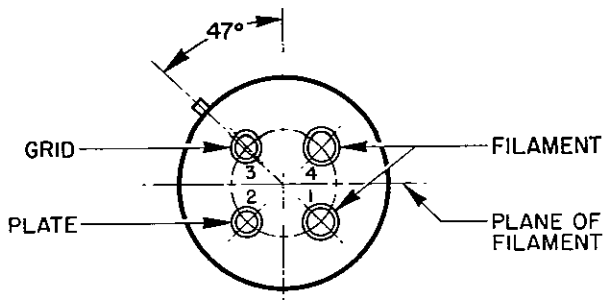
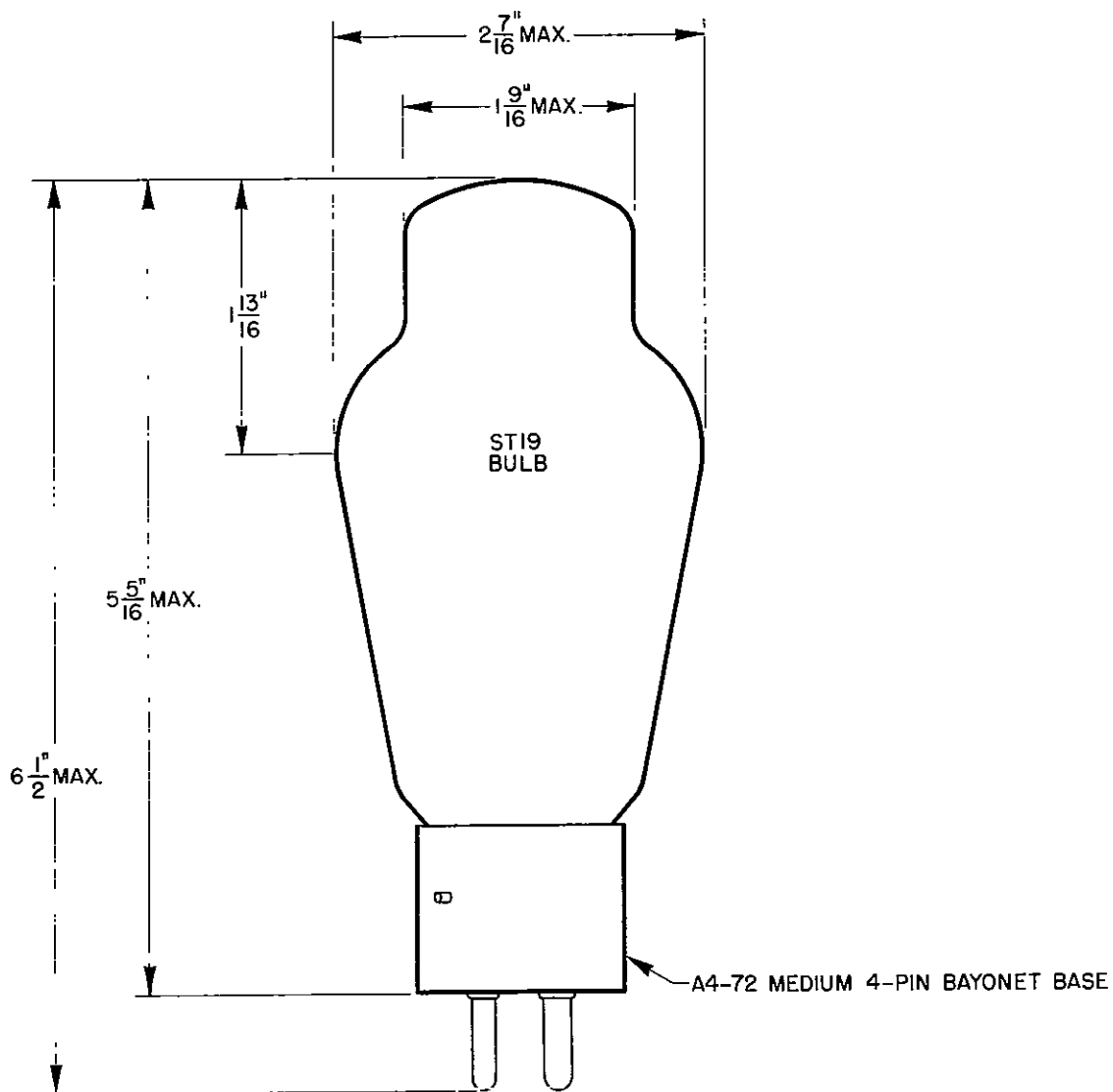

***Western Electric***

A development of Bell Telephone Laboratories, the research laboratories of the American Telephone and Telegraph Company and the Western Electric Company.