



**5636**  
**PENTODE**  
 Five-Star Tube  
 ★ ★ ★ ★ ★

**FOR GATED-AMPLIFIER AND MIXER APPLICATIONS**

**8-LEAD SUBMINIATURE  
 SHARP-CUTOFF CHARACTERISTICS**

**SHOCK, VIBRATION RATINGS  
 HEATER-CYCLING RATING**

**DESCRIPTION AND RATING**

The 5636 is a subminiature dual-control pentode in which both grid-number 1 and grid-number 3 can be used as independent control electrodes. It is suitable for service as a gated or gain-controlled amplifier, or as a mixer at frequencies up to approximately 400 megacycles.

Intended for use in critical industrial and military applications in which operational dependability is of primary importance, the 5636 exhibits a high degree of mechanical strength and incorporates a heater-cathode construction capable of withstanding many-thousand cycles of intermittent operation. When used in on-off control applications, the tube will maintain its emission capabilities after long periods of operation under cutoff conditions.

**GENERAL**

**ELECTRICAL**

Cathode—Coated Unipotential

Heater Voltage, AC or DC . . . . .  $6.3 \pm 5\%$  Volts  
 Heater Current . . . . . 0.15 Amperes

**Direct Interelectrode Capacitances**

	With Shield*	Without Shield
Grid-Number 1 to Plate, maximum . . . . .	0.015	0.030 $\mu\mu\text{f}$
Grid-Number 3 to Plate, maximum . . . . .	1.1	1.1 $\mu\mu\text{f}$
Grid-Number 1 to All . . . . .	4.0	4.0 $\mu\mu\text{f}$
Grid-Number 3 to All . . . . .	4.0	3.8 $\mu\mu\text{f}$
Plate to All . . . . .	3.4	1.9 $\mu\mu\text{f}$
Grid-Number 1 to Grid-Number 3, maximum . . . . .	0.15	0.17 $\mu\mu\text{f}$

\* With external shield of 0.405-inch inside diameter connected to cathode.

**MECHANICAL**

Mounting Position—Any

Envelope—T-3, Glass

Base—E8-10, Subminiature

**BASING DIAGRAM**

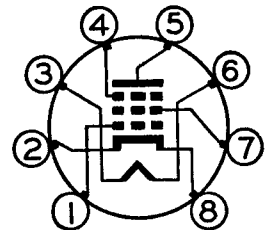

RETMA 8DC

**TERMINAL CONNECTIONS**

- Lead 1—Grid Number 1
- Lead 2—Cathode
- Lead 3—Heater
- Lead 4—Grid Number 3
- Lead 5—Plate
- Lead 6—Heater
- Lead 7—Grid Number 2 (Screen)
- Lead 8—Cathode

**PHYSICAL DIMENSIONS**

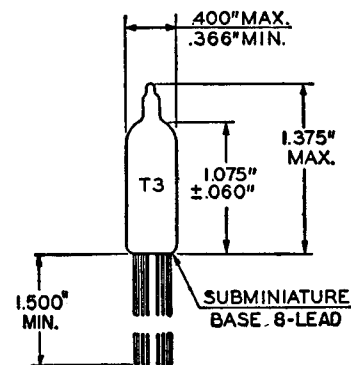

RETMA 3-1



## MAXIMUM RATINGS

### DESIGN-MAXIMUM VALUES†

Plate Voltage . . . . .	165	Volts
Screen Voltage . . . . .	155	Volts
Positive DC Grid-Number 3 Voltage . . . . .	30	Volts
Negative DC Grid-Number 1 Voltage . . . . .	55	Volts
Plate Dissipation . . . . .	0.55	Watts
Screen Dissipation . . . . .	0.45	Watts
DC Cathode Current . . . . .	16	Milliamperes
Heater-Cathode Voltage		
Heater Positive with Respect to Cathode . . . . .	200	Volts
Heater Negative with Respect to Cathode . . . . .	200	Volts
Bulb Temperature at Hottest Point . . . . .	220	C
Grid-Number 1 Circuit Resistance . . . . .	1.1	Megohms

† Design-Maximum Ratings are the limiting values expressed with respect to bogie tubes at which satisfactory tube life can be expected to occur. To obtain satisfactory circuit performance, therefore, the equipment designer must establish the circuit design so that no design-maximum value is exceeded with a bogie tube under the worst probable operating conditions with respect to supply-voltage variation, equipment component variation, equipment control adjustment, load variation, and environmental conditions.

## CHARACTERISTICS AND TYPICAL OPERATION

### AVERAGE CHARACTERISTICS

Plate Voltage . . . . .	100	100	Volts
Screen Voltage . . . . .	100	100	Volts
Grid-Number 3 Voltage . . . . .	-1	‡	Volts
Cathode-Bias Resistor . . . . .	150	150	Ohms
Plate Resistance, approximate . . . . .		0.11	Megohms
Grid-Number 1 Transconductance . . . . .		3200	Micromhos
Grid-Number 3 Transconductance . . . . .	950	...	Micromhos
Plate Current . . . . .		5.3	Milliamperes
Screen Current . . . . .		3.6	Milliamperes
Grid-Number 1 Voltage, approximate			
I <sub>b</sub> = 10 Microamperes . . . . .		-7.5	Volts
Grid-Number 3 Voltage, approximate			
I <sub>b</sub> = 10 Microamperes . . . . .	-8	....	Volts

‡ Grid-Number 3 connected to cathode at socket.

## CHARACTERISTICS LIMITS

	Minimum	Maximum	
<b>Heater Current</b>			
Ef = 6.3 volts . . . . . Initial	140	160	Milliamperes
500-Hr	138	164	Milliamperes
<b>Plate Current</b>			
Ef = 6.3 volts, Eb = 100 volts, Ec2 = 100 volts, Rk = 150 ohms (by-passed), g3 tied to k . . . . . Initial	3.7	6.9	Milliamperes
<b>Screen Current</b>			
Ef = 6.3 volts, Eb = 100 volts, Ec2 = 100 volts, Rk = 150 ohms (by-passed), g3 tied to k . . . . . Initial	2.8	5.4	Milliamperes
<b>Grid-Number 1 Transconductance (1)</b>			
Ef = 6.3 volts, Eb = 100 volts, Ec2 = 100 volts, Rk = 150 ohms (by-passed), g3 tied to k . . . . . Initial	2700	4000	Micromhos
<b>Transconductance Change with Heater Voltage</b>			
Difference between Grid-Number 1 Transconductance (1) and Grid- Number 1 Transconductance at Ef = 5.7 volts (other conditions the same) expressed as a percentage of Grid-Number 1 Transconductance (1) . . . . . Initial	. . . .	15	Percent
500-Hr	. . . .	15	Percent
<b>Transconductance Change with Operation</b>			
Difference between Grid-Number 1 Transconductance (1) initially and after operation expressed as a percentage of initial value . . . . . 500-Hr	. . . .	20	Percent
<b>Average Transconductance Change with Operation</b>			
Average of Values for "Transconductance Change with Operation" . . . . 500-Hr	. . . .	15	Percent
<b>Grid-Number 3 Transconductance</b>			
Ef = 6.3 volts, Eb = 100 volts, Ec3 = -1.0 volts, Ec2 = 100 volts, Rk = 150 ohms (by-passed) . . . . . Initial	500	1800	Micromhos
<b>Plate Current Cutoff (1)</b>			
Ef = 6.3 volts, Eb = 100 volts, Ec2 = 100 volts, Ec1 = -7.5 volts, g3 tied to k. Initial	. . . .	100	Microamperes
<b>Plate Current Cutoff (2)</b>			
Ef = 6.3 volts, Eb = 100 volts, Ec2 = 100 volts, Ec1 = -4.5 volts, g3 tied to k . . . . . Initial	50	. . . .	Microamperes
<b>Plate Current Cutoff (3)</b>			
Ef = 6.3 volts, Eb = 100 volts, Ec3 = -8.0 volts, Ec2 = 100 volts, Rk = 150 ohms . . . . . Initial	. . . .	100	Microamperes
<b>Plate Current Cutoff (4)</b>			
Ef = 6.3 volts, Eb = 100 volts, Ec3 = -6.0 volts, Ec2 = 100 volts, Ec1 = -3.0 volts . . . . . Initial	5.0	. . . .	Microamperes
<b>Plate Current Cutoff (5)</b>			
Ef = 6.3 volts, Eb = 100 volts, Ec3 = -15 volts, Ec2 = 100 volts, Ec1 = -2.0 volts . . . . . Initial	. . . .	20	Microamperes

**CHARACTERISTICS LIMITS (Cont'd)**

		<b>Minimum</b>	<b>Maximum</b>	
<b>Interelectrode Capacitances</b>				
Grid-Number 1 to Plate (g1 to p) . . . . .	Initial	. . . .	0.015	$\mu\mu\text{f}$
Grid-Number 3 to Plate (g3 to p) . . . . .	Initial	. . . .	1.10	$\mu\mu\text{f}$
Grid-Number 1 to All (g1 to h, k, g2, g3, p) . . . . .	Initial	3.5	4.5	$\mu\mu\text{f}$
Grid-Number 3 to All (g3 to h, k, g1, g2, p) . . . . .	Initial	3.5	4.5	$\mu\mu\text{f}$
Output (p to h, k, g1, g2, g3) . . . . .	Initial	2.9	3.9	$\mu\mu\text{f}$
Grid-Number 1 to Grid-Number 3 (g1 to g3) . . . . .	Initial	. . . .	0.15	$\mu\mu\text{f}$
Measured with external shield of 0.405-inch inside diameter connected to cathode.				
<b>Negative Grid-Number 1 Current</b>				
Ef = 6.3 volts, Eb = 100 volts, Ec2 = 100 volts, Rk = 150 ohms (by-passed), Rg1 = 1.0 meg, g3 tied to k. . . . .				
	Initial	0	0.3	Microamperes
	500-Hr	0	0.9	Microamperes
<b>Heater-Cathode Leakage Current</b>				
Ef = 6.3 volts, Ehk = 100 volts				
Heater Positive with Respect to Cathode . . . . .				
	Initial	0	5	Microamperes
	500-Hr	0	10	Microamperes
Heater Negative with Respect to Cathode . . . . .				
	Initial	0	5	Microamperes
	500-Hr	0	10	Microamperes
<b>Interelectrode Leakage Resistance</b>				
Ef = 6.3 volts. Polarity of applied d-c interelectrode voltage is such that no cathode emission results.				
Grid-Number 1 to All at 100 Volts DC . . . . .				
	Initial	100	. . . .	Megohms
	500-Hr	50	. . . .	Megohms
Plate to All at 300 Volts DC . . . . .				
	Initial	100	. . . .	Megohms
	500-Hr	50	. . . .	Megohms
<b>Vibrational Noise Output Voltage, RMS</b>				
Ef = 6.3 volts, Ebb = 100 volts, Ec2 = 100 volts, Rk = 150 ohms (by-passed), R <sub>L</sub> = 10,000 ohms, g3 tied to k, vibrational acceleration = 15 G at 40 cps. . . . .				
	Initial	. . . .	60	Millivolts
<b>Grid-Number 1 Emission Current</b>				
Ef = 7.5 volts, Eb = 100 volts, Ec2 = 100 volts, Ec1 = -7.5 volts, Rg1 = 1.0 meg, g3 tied to k. . . . .				
	Initial	0	0.5	Microamperes

The indicated 500-hour values are life-test end points for the following conditions of operation: Ef = 6.3 volts, Eb = 100 volts, Ec2 = 100 volts, Rk = 150 ohms, Rg1 = 1.0 meg, g3 tied to k, Ehk = 200 volts with heater positive with respect to cathode, and bulb temperature = 220 C minimum.

## **SPECIAL TESTS AND RATINGS**

### **Stability Life Test**

Statistical sample operated for one hour to evaluate and control initial variations in transconductance.

### **Survival Rate Life Test**

Statistical sample operated for one hundred hours to evaluate and control early-life electrical and mechanical in-operatives.

### **Heater-Cycling Life Test**

Statistical sample operated for 2000 cycles to evaluate and control heater-cathode defects. Conditions of test include  $E_f = 7.0$  volts cycled for one minute on and four minutes off,  $E_b = E_{c3} = E_{c2} = E_{c1} = 0$  volts, and  $E_{hk} = 140$  volts RMS.

### **Shock Rating—450 G**

Statistical sample subjected to five impact accelerations of 450 G in each of four different positions. The accelerating forces are applied by the Navy-type, High Impact (flyweight) Shock Machine for Electronic Devices or its equivalent.

### **Fatigue Rating—2.5 G**

Statistical sample subjected to vibrational acceleration of 2.5 G for 32 hours minimum in each of three different positions. The sinusoidal vibration is applied at a fixed frequency between 25 and 60 cycles per second.

### **Altitude Rating—60,000 Feet**

Statistical sample subjected to pressure of 55 millimeters of mercury to evaluate and control arcing and corona.

**Note:** The conditions for some of the indicated tests have deliberately been selected to aggravate tube failures for test and evaluation purposes. In no sense should these conditions be interpreted as suitable circuit operating conditions.

In the design of military equipment employing this tube, reference should be made to the appropriate MIL-E-1B specification.

AVERAGE PLATE CHARACTERISTICS

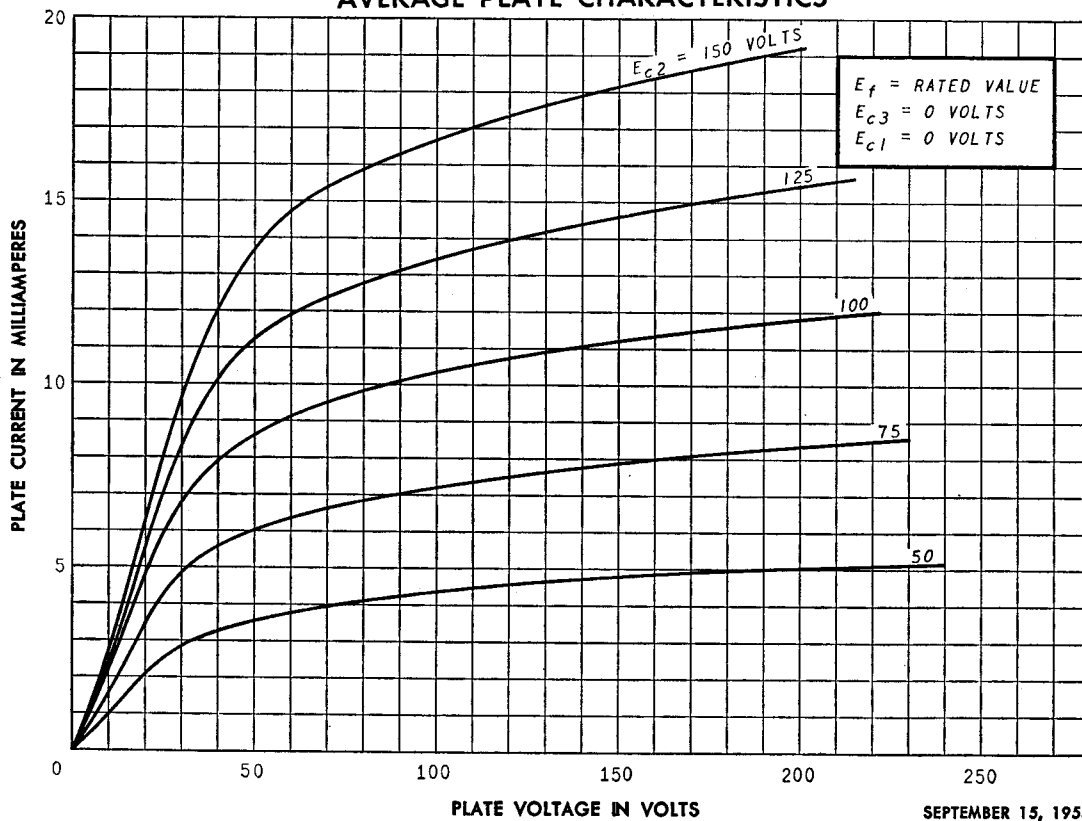

SEPTEMBER 15, 1955

AVERAGE PLATE CHARACTERISTICS

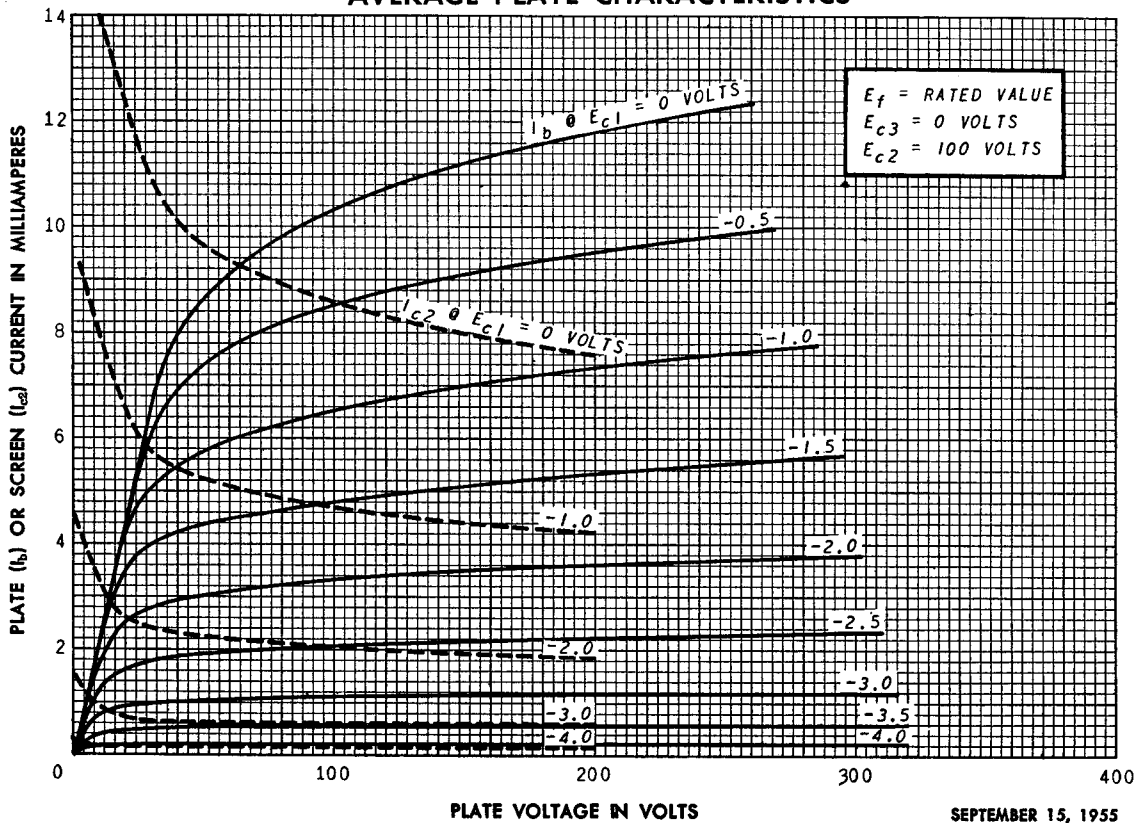

SEPTEMBER 15, 1955

AVERAGE PLATE CHARACTERISTICS

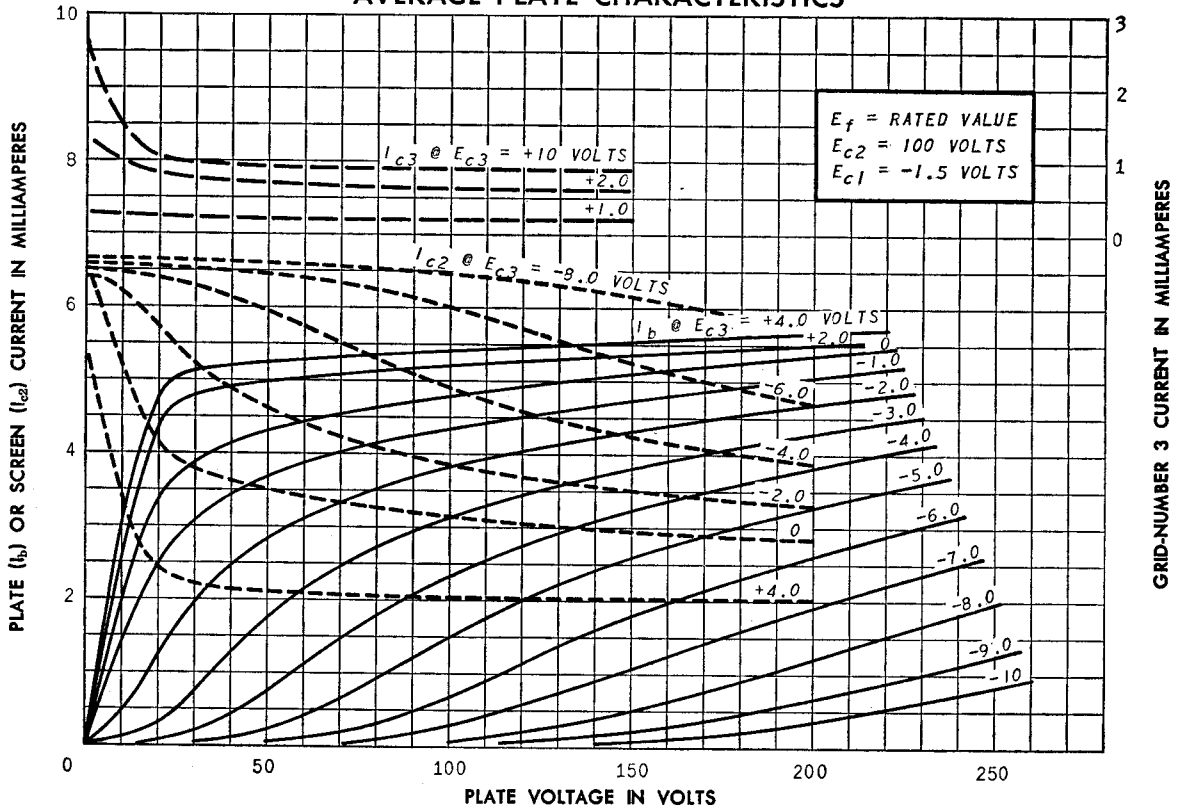

SEPTEMBER 15, 1955

AVERAGE TRANSFER CHARACTERISTICS

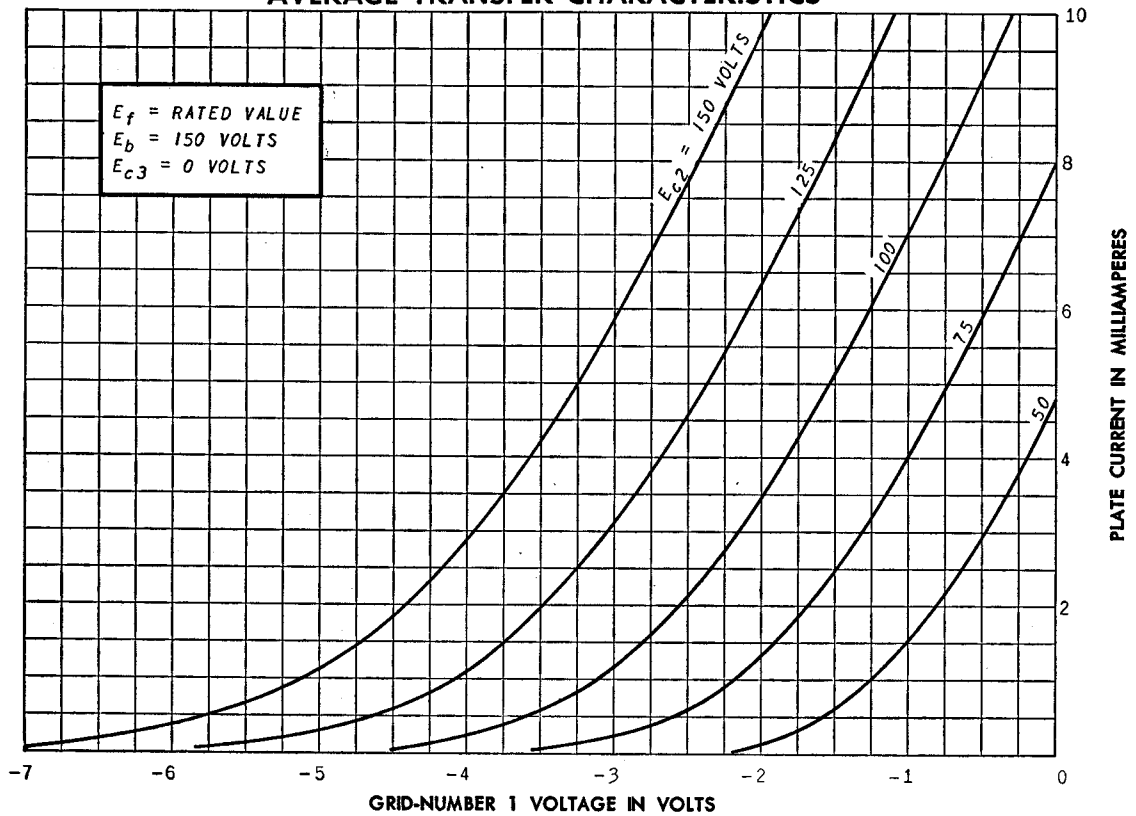

SEPTEMBER 15, 1955

AVERAGE TRANSFER CHARACTERISTICS

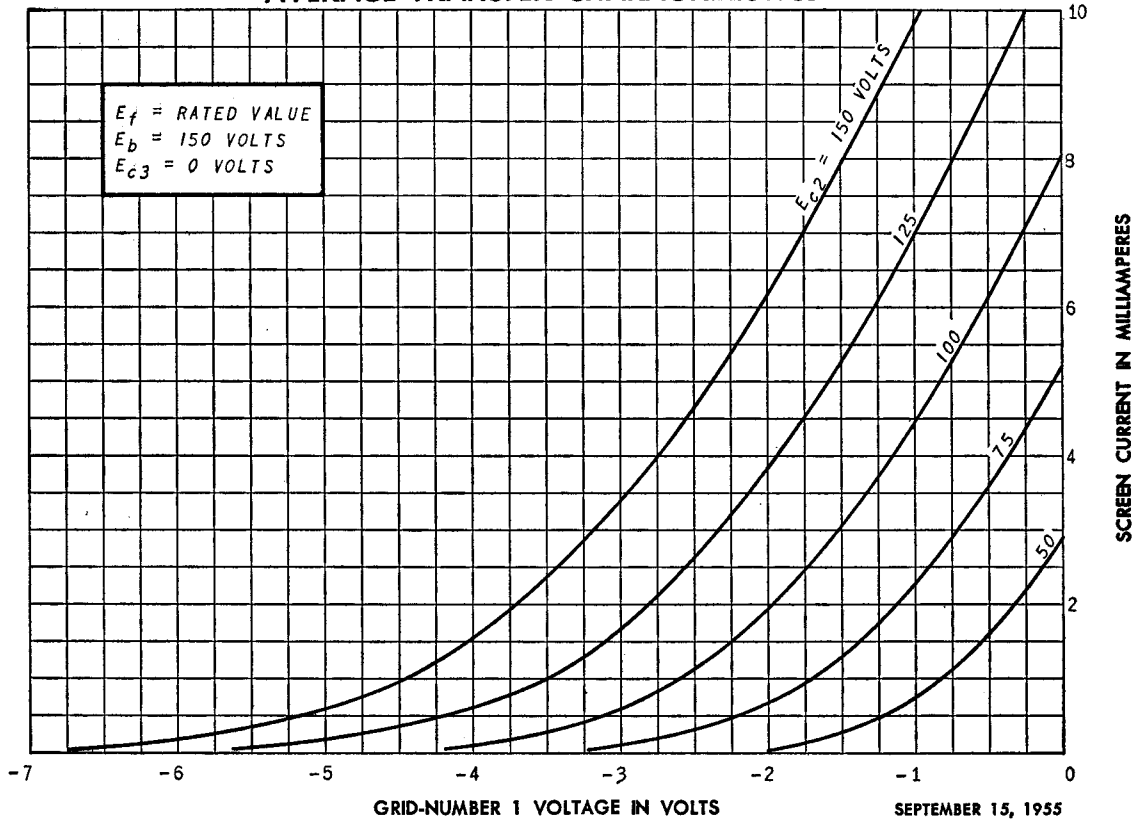

AVERAGE TRANSFER CHARACTERISTICS

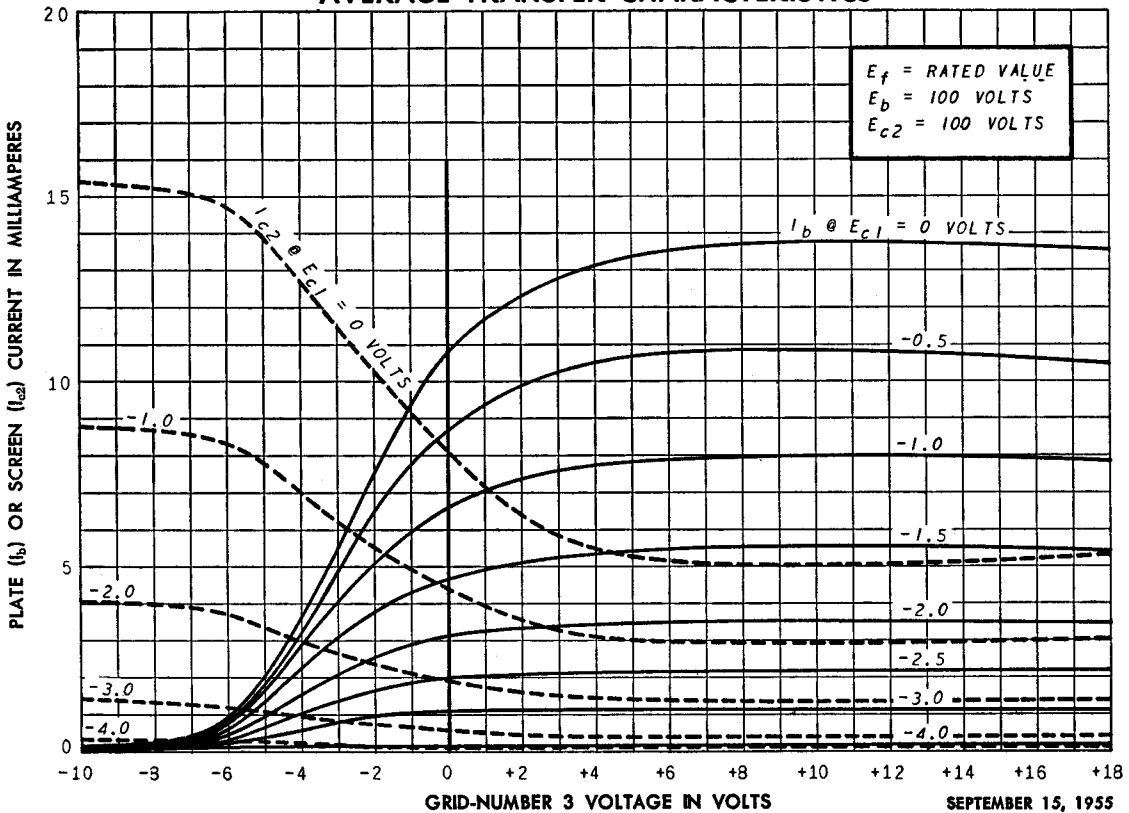



AVERAGE TRANSFER CHARACTERISTICS

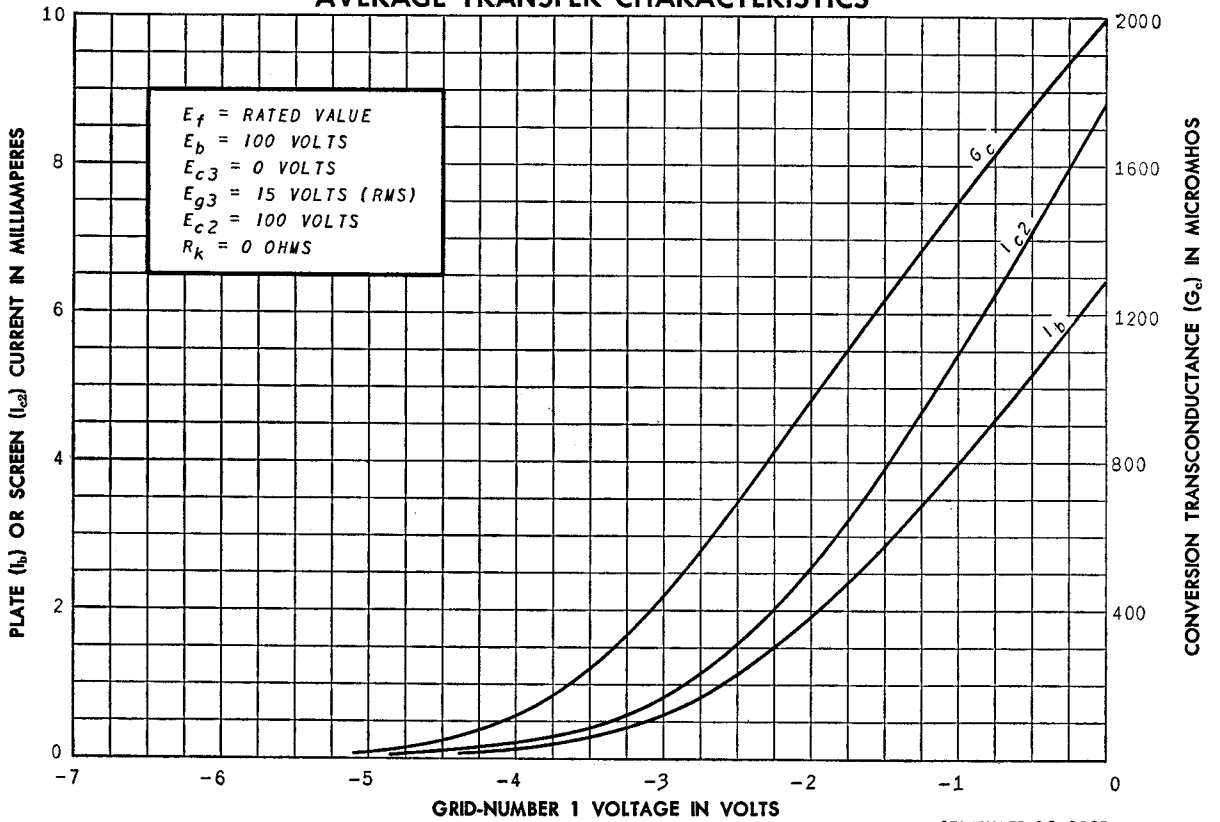

SEPTEMBER 15, 1955

AVERAGE TRANSFER CHARACTERISTICS

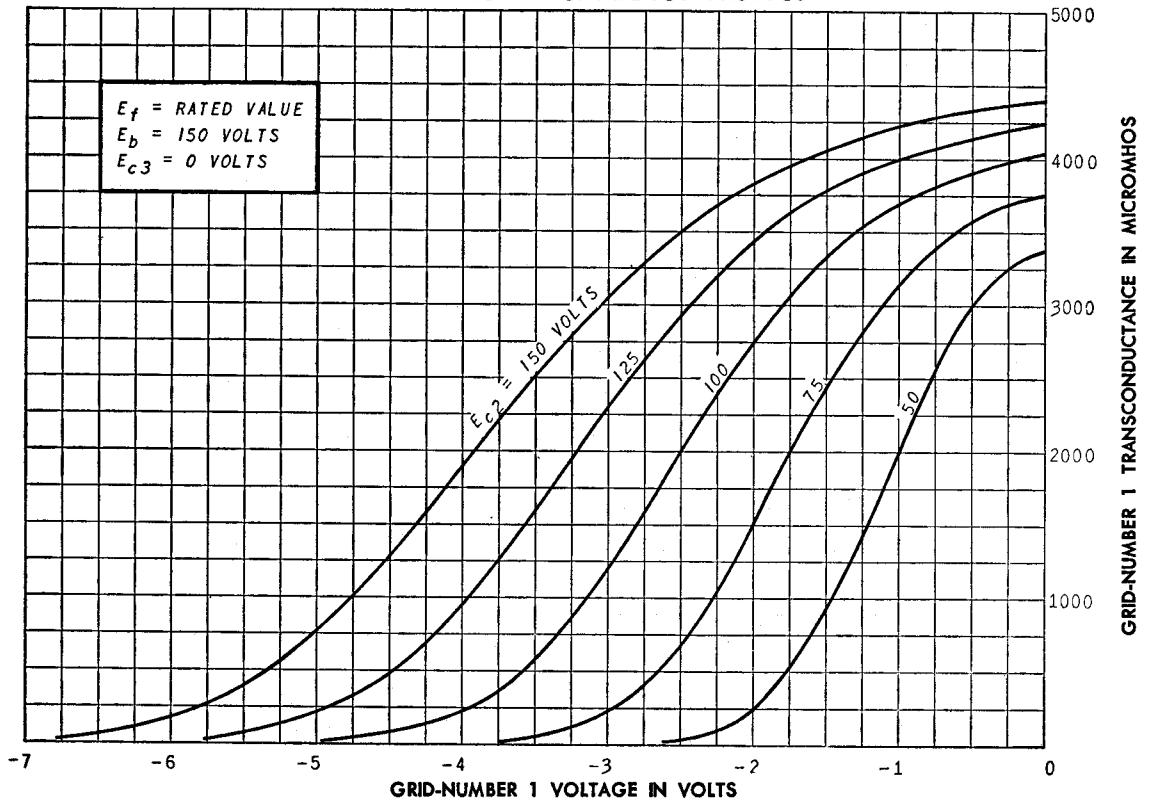

SEPTEMBER 15, 1955

AVERAGE TRANSFER CHARACTERISTICS

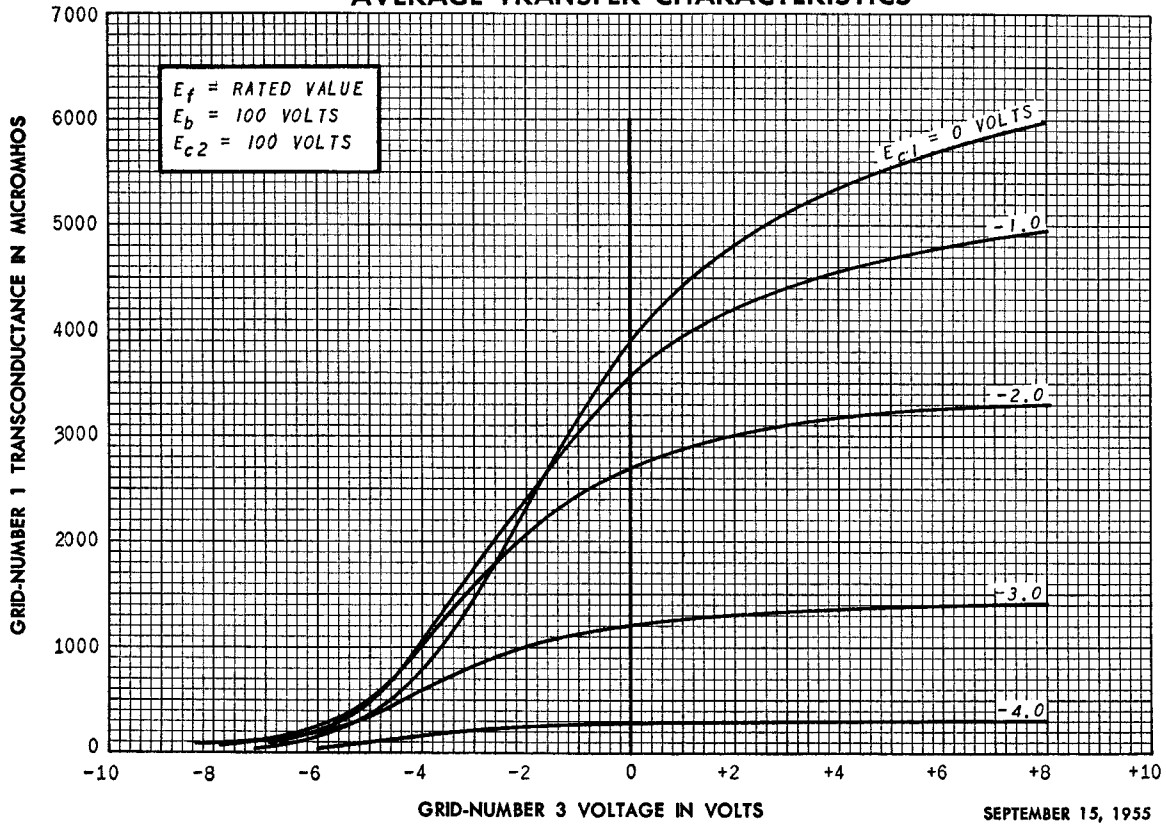

AVERAGE TRANSFER CHARACTERISTICS

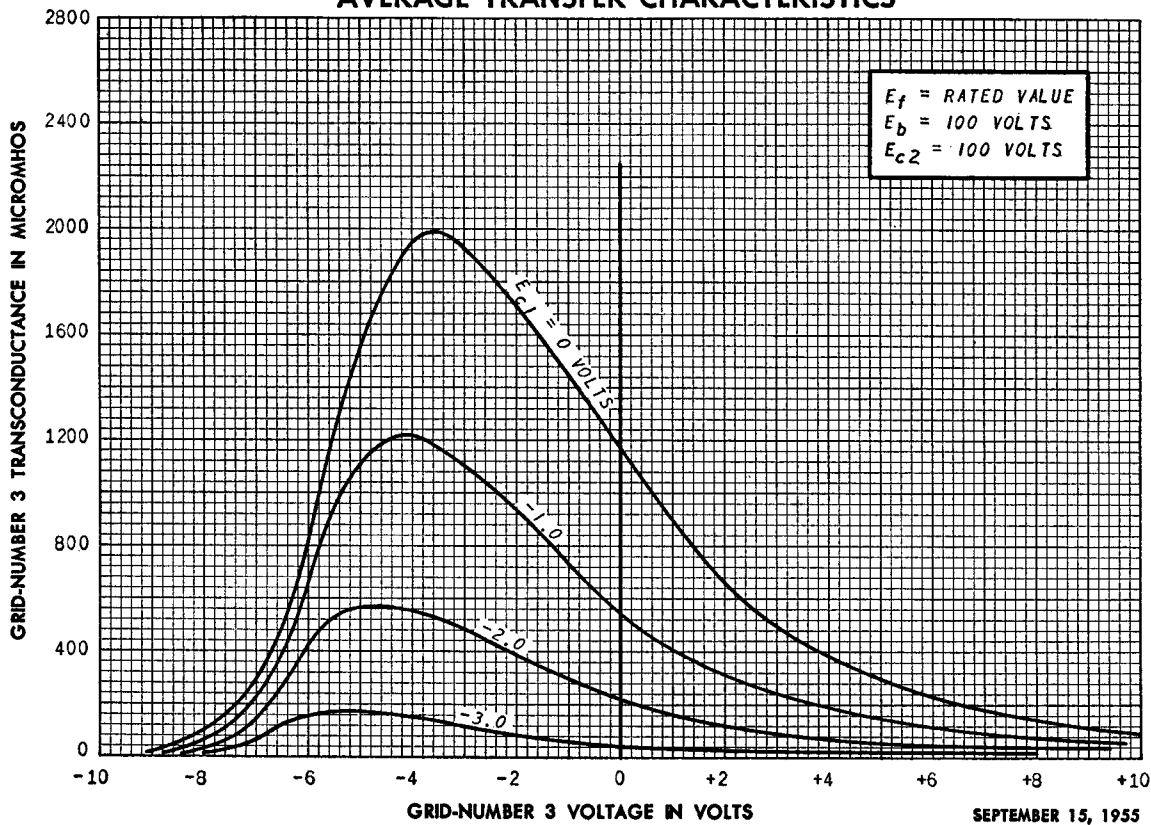

AVERAGE CHARACTERISTICS

