

# SUBMINIATURE TETRODE THYRATRON

## DESCRIPTION

This reliable subminiature xenon tetrode thyatron is from the Bendix Red Bank line of reliable gas tubes. It is specifically designed for use in counters, grid control rectifiers, and other control circuits such as Gyro erection systems, missile systems and automatic flight control applications where freedom from early failures, long average service life and uniform operating characteristics are extremely important. In addition, this tube is designed for use in equipment where high levels of shock, vibration and other accelerations are to be encountered. Each tube is given a 24-hour run-in under various conditions of overload comparable to those to be encountered in service. This run-in period serves to reduce early failures by eliminating tubes that may have minor defects which could possibly lead to failure under operating conditions.

The mechanical and electrical design, combined with a program of 100% microscopic inspection during manufacture, assures a high degree of reliability in all applications where severe mechanical shock and vibration may be encountered. Careful exhaust to a high degree of vacuum is employed before xenon is put into the envelope to ensure a long life expectancy. The large cathode area operating at moderate temperatures gives long service life. Small mass of the tube elements and electrode spacing provide increased ability of the tube to withstand shock and vibration. This tube has a control character-

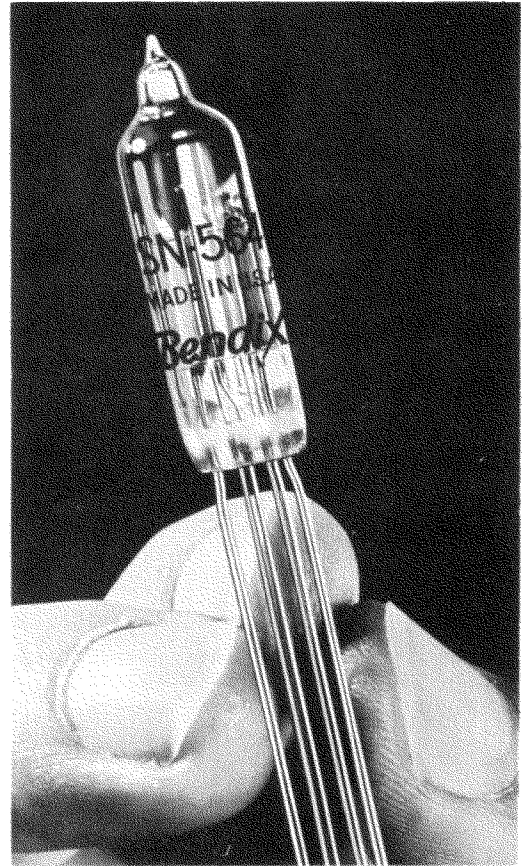

istic which is virtually independent of ambient temperature over a comparatively wide range. (Refer to the enlarged view on the last page for the many improved features of this tube.)

## ELECTRICAL RATINGS

Heater Voltage.....	6.3 volts
Heater Current.....	0.15 amperes
Peak Plate Inverse Voltage.....	500 volts
Peak Forward Plate Voltage.....	500 volts
Maximum Negative Grid 1 Voltage (Before Conduction).....	-200 volts
Maximum Negative Grid 2 Voltage (Before Conduction).....	-100 volts
Average Cathode Current.....	16 mA <sub>dc</sub>
Peak Cathode Current.....	100 mA
Heater-Cathode Voltage:	
Maximum.....	+25 V <sub>dc</sub>
Minimum.....	-100 V <sub>dc</sub>
Cathode Warm-up Time.....	10 sec
Maximum Negative Grid 1 or Grid 2 Voltage During Conduction.....	-10 volts

## MECHANICAL DATA

Base.....	Button: Subminiature 8-pin long leads
Envelope.....	T-3 (8-1)
Bulb Length (Max).....	1.375 in.
Diameter (Max).....	0.400 in.
Mounting Position.....	Any
Altitude Rating (Max).....	60,000 ft.
Bulb Temperature (Max).....	125°C
Ambient Temperature (Min).....	-55°C
Cathode.....	Coated Unipotential

THE **Bendix** CORPORATION

*Red Bank* DIVISION, EATONTOWN, NEW JERSEY

## ELECTRICAL CHARACTERISTICS AND TEST DATA

### END OF LIFE

#### TEST CONDITIONS AND CHARACTERISTICS LIMITS

CHARACTERISTIC	SYMBOL	MIN.	DESIGN CENTER	MAX.	UNITS
PRODUCTION TESTS					
Heater Current	I <sub>f</sub>	138	150	164	mA
Heater-Cathode Leakage	I <sub>hk</sub>	—	—	±20	μAdc
Grid Voltage (1)	E <sub>g1</sub>	-0.8	—	-5.0	Vdc
Grid Voltage (2)	E <sub>g2</sub>	—	—	—	Vdc
Anode Voltage	E <sub>b</sub>	—	—	70	Vdc
Pulse Emission	I <sub>d</sub>	—	—	100	Vac
Short and Continuity					
ELECTRODE:	E <sub>f</sub>	E <sub>c2</sub>			
TEST CONDITIONS:	6.3 volts	0	±25 Vdc -100 Vdc		

#### ADDITIONAL TESTS

In addition to the production and design tests shown other tests are performed on a sampling basis to assure a high outgoing quality level. See below.

TEST	CONDITIONS	DURATION
Heater cycling Life Test	On 1 Min. Off 4 Min. E <sub>f</sub> = 7.0 E <sub>hk</sub> = 18	2500 on-off cycles
High Temp. Life Test	Under "Test Conditions" Bulb Temp. 125° C	600 Hours
Survival Rate Life Test	Under "Test Conditions"	100 Hours
High Level Fatigue Test	2.5G Excitation 60/sec. rep. rate	96 Hours
Shock	500 G	
Altitude Test	60,000 Feet	
Glass Strain Test	Boiling Water to Ice Water	15 sec. hot 5 sec. cold
Lead Fatigue	1 Pound	4 Arcs
Mount Inspection	100% Test—Microscopic Inspection	

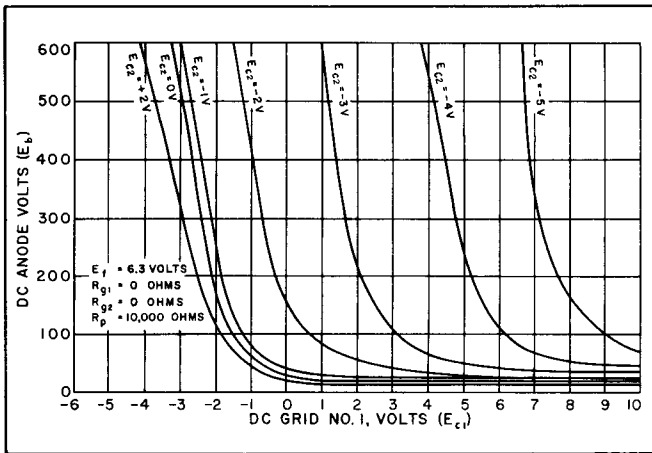

**AVERAGE CONTROL CHARACTERISTICS**

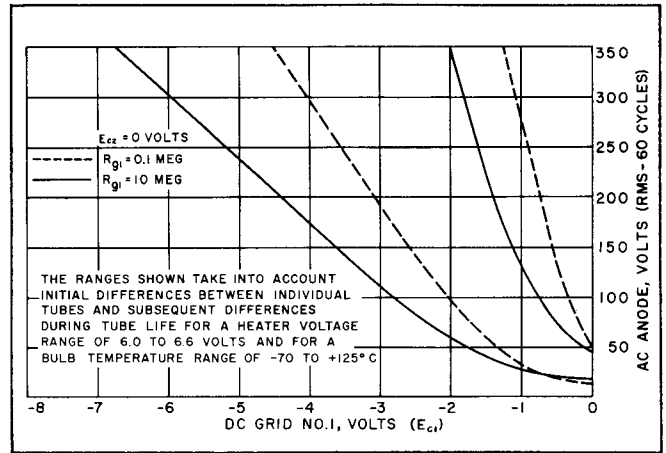

**OPERATIONAL RANGE OF CRITICAL GRID VOLTAGE**

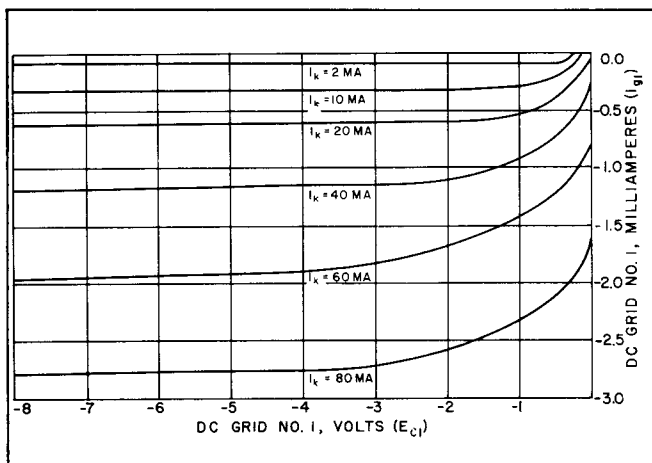

**AVERAGE GRID CHARACTERISTICS DURING ANODE CONDUCTION**

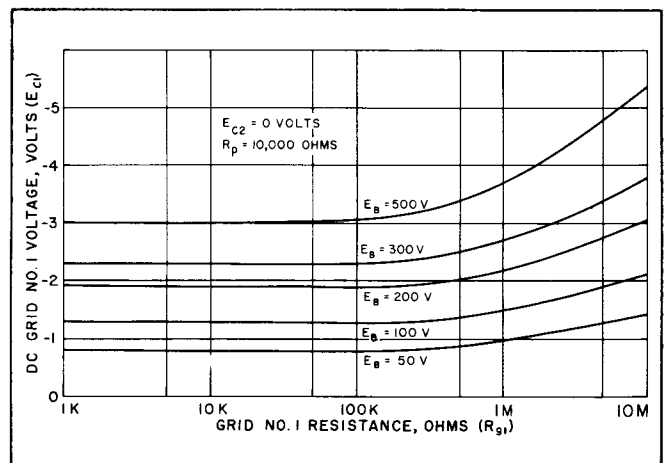

**AVERAGE GRID VOLTAGES vs. GRID RESISTANCE**

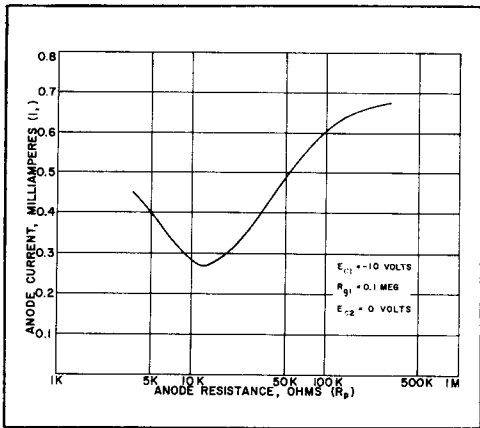

**AVERAGE ANODE CURRENT REQUIRED TO MAINTAIN CONDUCTION**

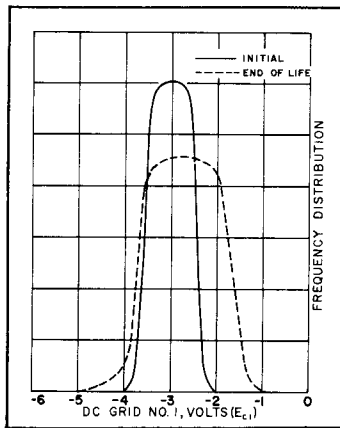

**AVERAGE GRID FIRING DISTRIBUTION**

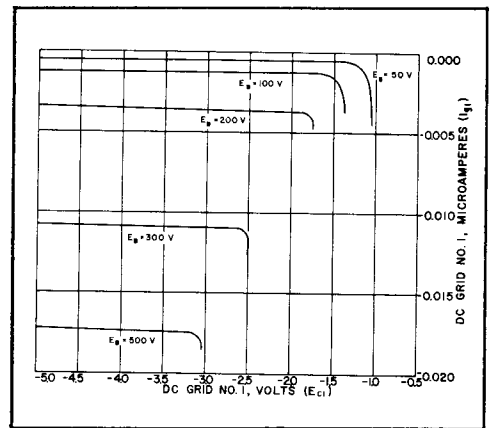

**AVERAGE GRID CHARACTERISTICS BEFORE ANODE CONDUCTION**

## APPLICATION NOTES

Special attention should be given to the temperatures at which the tubes are to be operated. Reliability will be seriously impaired if maximum bulb temperature is exceeded. The life expectancy will be reduced if conditions other than those specified for life test are imposed on the tube and will be reduced appreciably if absolute maximum ratings are exceeded. Both reliability and performance are directly related to the degree that regulation of the heater voltage is maintained at its center rated value.

The increased rating chart is presented to emphasize the dangers of operating simultaneously at or near all maxima. In general, the effect on life of operation at increased ratings is additive and cumulative. Interpolation within this chart will give the designer a general idea of the life expectancy and reliability of his application. Each proposed application should be life tested under maximum environmental conditions in order to check that the design gives the desired reliability.

Typical use of this subminiature thyatron is in grid-controlled rectifiers, counter circuits and various control

circuits where a high degree of reliability is required. When conservatively used, this tube has a life expectancy of over 1000 hours.

## EFFECT ON LIFE OF INCREASED RATINGS

RATING OR CHARACTERISTIC	OPERATING CONDITIONS		
	CONSERVATIVE	TYPICAL	MAXIMUM
Heater Voltage	6.3V ± 2%	6.3V ± 3%	6.3V ± 5%
Plate Voltage (dc)	350 Vdc	400 Vdc	500 Vdc
Plate Voltage (ac)	275 Vac	300 Vac	350 Vac
Peak Plate Voltage Inv.	350 V	400 V	500 V
Plate Current (Av.)	12mA	14mA	16mA
Cathode Current (Peak)	50mA	65mA	100mA
H-K Voltage	± 10V	+20; -90V	+25; -100V
Grid Resistance	100,000 ohms	1,000,000 ohms	10,000,000 ohms
Bulb Temperature	85°C	100°C	125°C
Altitude	0-50,000 ft	50,000 ft.	60,000 ft.
Vibration	0 G	2.5 G	5 G
LIFE EXPECTANCY	MAXIMUM	HIGH	MEDIUM

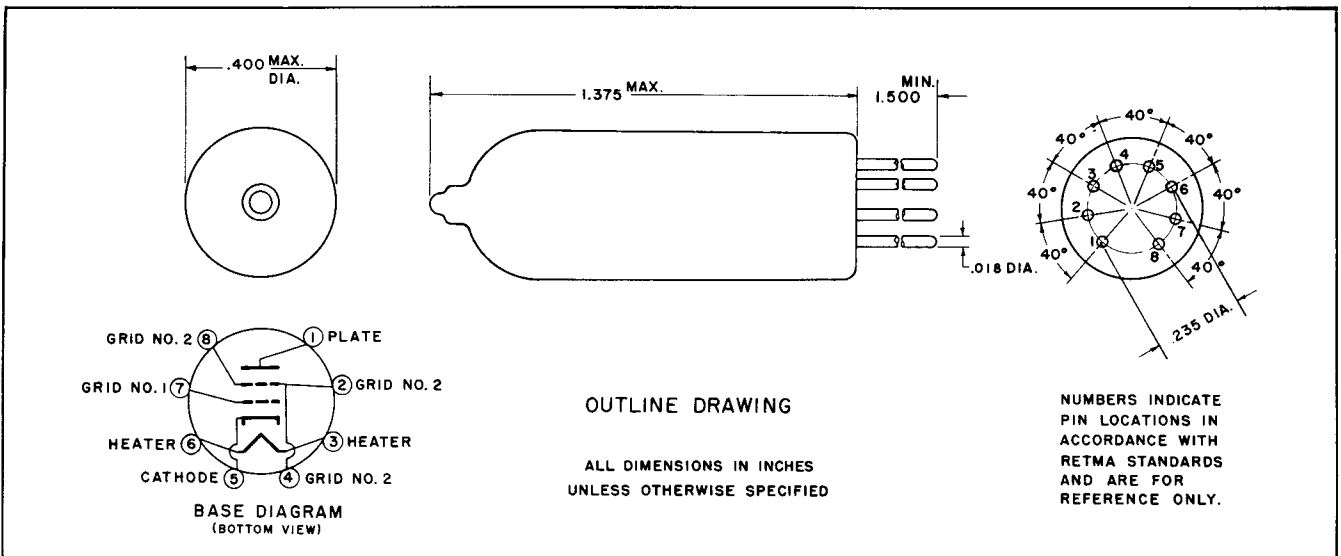

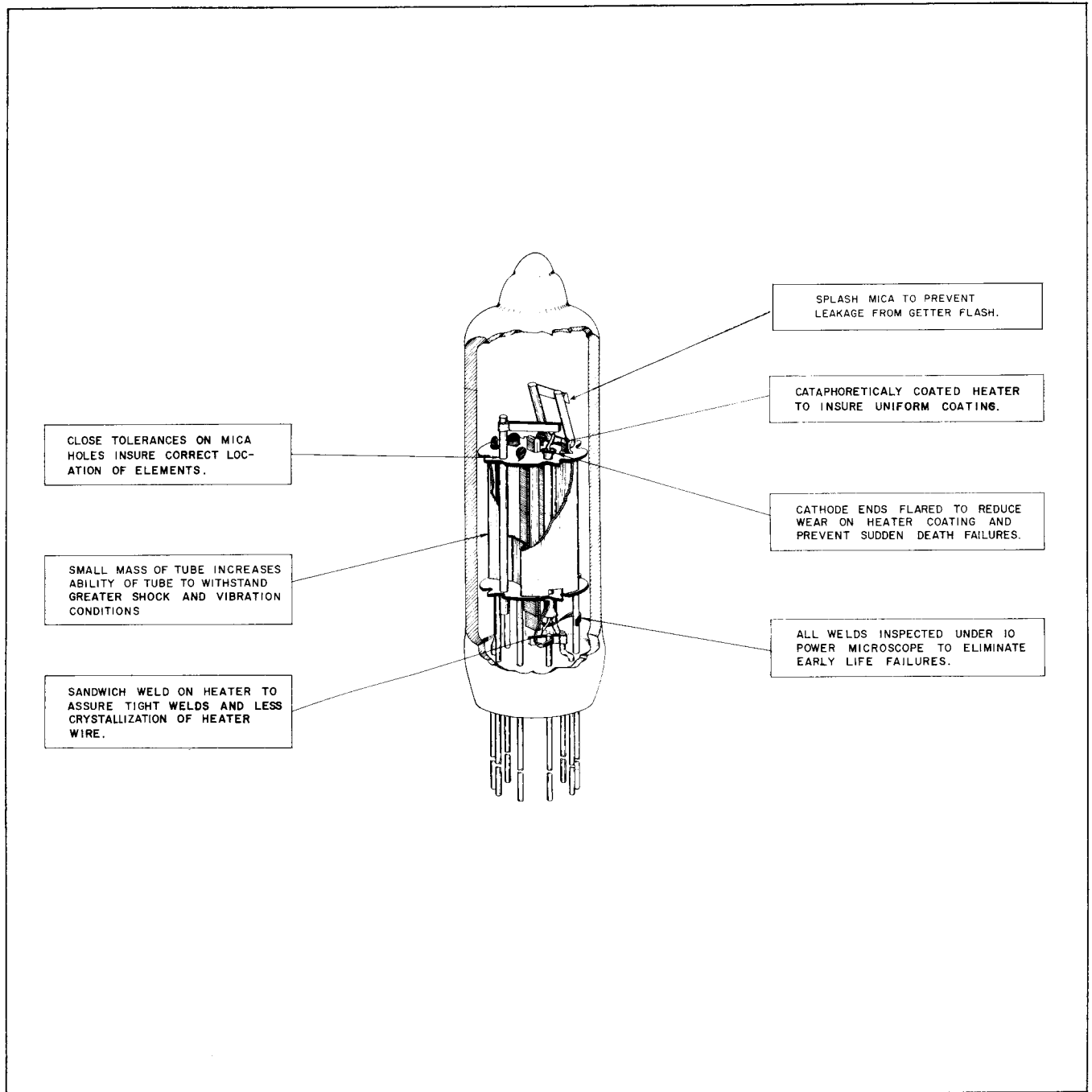

**STRUCTURAL FEATURES OF 5643 PROVIDE HIGH RELIABILITY AND LONG LIFE.**

THE *Bendix* CORPORATION  
*Red Bank* DIVISION, EATONTOWN, NEW JERSEY

West Coast Sales & Service: 117 E. Providencia Ave., Burbank, Calif.

Export Sales & Service: Bendix International Division,  
205 E. 42nd St., New York 17, N.Y.

Canadian Distributor: Computing Devices of Canada, Ltd., P.O. Box 508,  
Ottawa 4, Ontario