



*Excellence in Electronics*

**TYPE  
CK5889**

The CK5889 is a subminiature electrometer pentode with a 7.5 milliamper filament but otherwise electrically similar to type CK5886. The control grid is at the top of the bulb which is completely encircled by a permanently bonded guard ring. ‡

**MECHANICAL DATA**

ENVELOPE : T-3 Glass

EASE : None (0.016" tinned flexible leads. Length: 1.5" min. \*  
Spacing: Leads 3-5 0.10" center to center. Other  
Leads 0.05" center to center)

TERMINAL CONNECTIONS : (Red dot adjacent to Lead 1)

Lead 1 Plate	Lead 4 Omitted
Lead 2 Screen Grid	Lead 5 Filament
Lead 3 Filament, Positive; One Deflector	Negative; One Deflector Top Lead Control Grid

**ELECTRICAL DATA**

RATINGS - ABSOLUTE MAXIMUM VALUES :

Filament Voltage (dc)	1.55 volts
Plate Voltage	45 volts
Screen Voltage	45 volts
Cathode Current	300 $\mu$ a

AVERAGE CHARACTERISTICS AND TYPICAL OPERATION : (Pentode Connection) ▲

Filament Voltage *	1.25 volts
Filament Current	7.5 ma.
Plate Voltage	12 volts
Screen Grid Voltage †	4.5 volts
Control Grid Voltage	-2 volts
Plate Current	4 $\mu$ a.
Screen Grid Current	4 $\mu$ a.
Amplification Factor (approx.)	250
Transconductance	10 $\mu$ mhos
Maximum Grid Current ‡	3 X 10 <sup>-15</sup> amp.

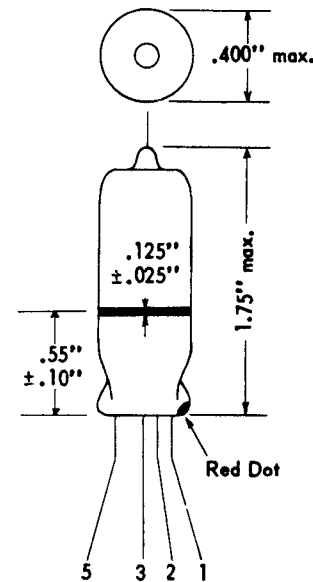

‡ Connection to the guard ring should be made by means of a spring clip or a twisted wire lead.

\* Excepting the control grid lead which is 0.375" min. from top of bulb.

▲ For the triode connection (Screen Grid connected to Plate) the average characteristics are: (Ep 10.5 V; Ec -3 V) Transconductance 150  $\mu$ mhos; Plate Current 180  $\mu$ A; Grid Current 10<sup>-13</sup> A.

■ Nominal value for dry-cell operation. If the filament voltage is constant or nearly so for very long periods of time (as, for example, from a regulated supply in a line-operated instrument design) it is recommended that the design center value be reduced to 1.0 volt.

† In order to ensure operation in the desired region of the grid characteristic, the equipment design should provide for the adjustment of the operating plate current by means of a variable screen grid supply rather than a variable control grid supply. The recommended range is 3.0 to 6.0 volts.

‡ The grid current is determined at the rated filament voltage, plate voltage, control grid voltage and plate current. The screen grid voltage is varied as per the preceding note.

**NOTES ON GRID CURRENT MEASUREMENTS**

**1. ELECTRICAL CONDITIONS:**

(a) The tube under test should be supplied with rated plate voltage, screen voltage, filament voltage and control grid bias, with the exception that, in the case of an operational condition aimed at the lowest possible grid current, it is preferable to fix the bias and adjust the screen voltage to give the required plate current within the limits of 3.0 to 6.0 volts, Esg.

(b) The stability of the supply potentials (including temperature stability) should be consistent with the expected grid current level together with a reasonable measuring time for a grid current determination. (See 3-d)

Tentative Data



## SUBMINIATURE PENTODE

## NOTES ON GRID CURRENT MEASUREMENTS (cont'd)

## 2. ENVIRONMENTAL CONDITIONS:

(a) The tube must be shielded from electric and magnetic fields as well as from all forms of radiant energy, including light, gamma rays, X-rays, Grenz rays and high-energy particles such as deuterons, protons and electrons.

(b) If the surrounding gas is at atmospheric pressure or approximately so, the relative humidity should be no higher than 20%. No surface treatment known (including dri-film, ceresin wax, etc., etc.) is as effective, at 50% or higher R.H., as a clean surface at 20% R.H. or less.

(c) Where drift is important, the temperature coefficients of other components, particularly the dielectrics in the exterior portion of the grid circuit, is usually the limiting factor rather than any temperature effects of the tube itself.

## 3. GRID RESISTOR TECHNIQUE

Although complete information must be available concerning the temperature coefficient, voltage coefficient and polar characteristics of the grid resistor used, this method is never the less the most convenient for a grid current measurement of a precision commensurable with the measuring time. Certain precautions, however, should be observed:

(a) The plate current shift should be measured when the grid resistor is shorted out.

(b) The plate current, upon cutting the resistor into the circuit, should be allowed either (1) at least five minutes to stabilize or (2) time enough so that the drift, referred to the grid, is not much more than one or two millivolts per minute. This latter presupposes that the resistor is  $10^{12}$  ohms and the expected grid current is 1 or  $2 \times 10^{-15}$  amps.

(c) The circuit should be arranged, if possible, so that C- (rather than A-) is grounded. This allows the use of a grounded resistor switch designed with a minimum of insulation.

(d) The grid circuit should be "padded" with a capacitance of the order of  $20$  or  $25 \times 10^{-12}$  F. Values appreciably higher than this build up an intolerable time constant while lower values begin to give considerable trouble from polar phenomena due to charges left on dielectrics (both interior and exterior to the tube) by the switching transient.

(e) The padding condenser should be designed so that at least 90% of its total capacitance is across an air dielectric, with the insulating member in a relatively weak part of the field. Such a design will reduce polar phenomena at this point to an irreducible minimum.

(f) The high side of the grid circuit should be grounded before opening the enclosure to change the tube under test. The relaxation times for dielectric absorption and decay currents associated with these dielectrics (including the grid resistor itself which is virtually a semi-conductor) are such that the mere act of touching an ungrounded circuit can (and often does) leave a charge which, in terms of millivolts, requires several hours to decay completely.

## 4. GRID CAPACITANCE TECHNIQUE

The classical method of determining grid current by measuring the absolute value of the grid capacitance and using this value together with the transconductance and the rate of change of the plate current as in:

$$C dE_g = T dI_p$$

is not recommended. At extremely low grid currents ( $10^{-15}$  amperes or less) polar phenomena cannot be separated from the charge being measured without observational studies extending into hours if not days while at slightly higher currents more direct methods are preferable.

## 5. CLEANING

Tubes subjected to excessive handling should be re-cleaned at the time of the grid current test. For this purpose alcohol is adequate unless severe contamination is suspected, in which case the alcohol dip may be preceded by other well-known glass cleaning agents. The container for the alcohol should be deep enough to allow dust, etc., from previous tubes to settle.

## 6. GENERAL

No tube of this class can be expected to show rated grid current in a few minutes of operation following a protracted period (a few weeks) of idleness. A re-distribution of residual gas molecules takes place when the filament is first raised to the temperature of operation and the practical result is an exponential decline of grid current with a time constant depending on:

- (a) Total time the tube has been operated.
- (b) Time since last operation.
- (c) Required operating grid current level.

In equipments entailing the most exacting requirements, continuous operation is recommended.

## ELECTROMETER CIRCUIT BIBLIOGRAPHY

- |                                 |                         |                               |
|---------------------------------|-------------------------|-------------------------------|
| 1. A Feedback Micromicroammeter | RSI, June 1939          | S. Roberts                    |
| 2. A Feedback D-C Meter         | Electronics, Sept. 1938 | J. M. Brumbaugh & A. W. Vance |
| 3. Electrometer Input Circuits  | Electronics, Dec. 1946  | H. A. Thomas                  |

RAYTHEON MANUFACTURING COMPANY

RECEIVING TUBE AND SEMICONDUCTOR OPERATIONS

SUBMINIATURE PENTODE

ELECTROMETER CIRCUIT BIBLIOGRAPHY ( cont ' d)

4. An Improved Vacuum Tube Microammeter	RSI, Dec. 1936	A. W. Vance
5. An Improved D-C Amplifier for Portable Ionization Chamber Instruments	RSI, Apr. 1951	N. F. Moody
6. Improvements in the Stability of the F P-54 Electrometer Tube	Jour. of App. Physics, Nov. 1945	J. M. Lafferty & K. H. Kingdon
7. Direct-Current Amplifier Circuits for Use with the Electrometer Tube	RSI, Apr. 1935	D. B. Penick
8. An Improved Balanced Circuit for Use with Electrometer Tubes	RSI, Aug. 1933	L. A. Turner & C. O. Siegelin
9. A Balanced Electrometer Tube and Amplifying Circuit for Small Direct Currents	RSI, Apr. 1934	G. P. Harnwell & S. N. Van Voorhis
10. An Improved D-C Amplifying Circuit	RSI, Oct. 1933	L. A. DuBridge & H. Brown

N. B. References 1 to 5 deal with feedback circuits in which considerable gain is realized in the electrometer input stage. References 6 to 10 are concerned with the classical type of balanced circuit working directly into the galvanometer.  
The CK5889 cannot be operated at low control grid currents in the space-charge connection because the amplification factor,  $G_2$  to P, is much too high (approximately 125).

AVERAGE TRANSFER CHARACTERISTICS

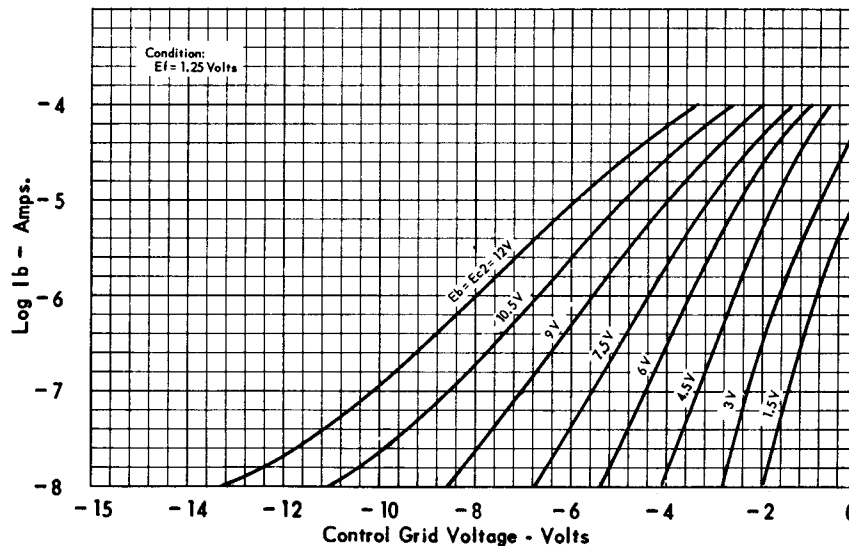



SUBMINIATURE PENTODE

AVERAGE PLATE CHARACTERISTICS

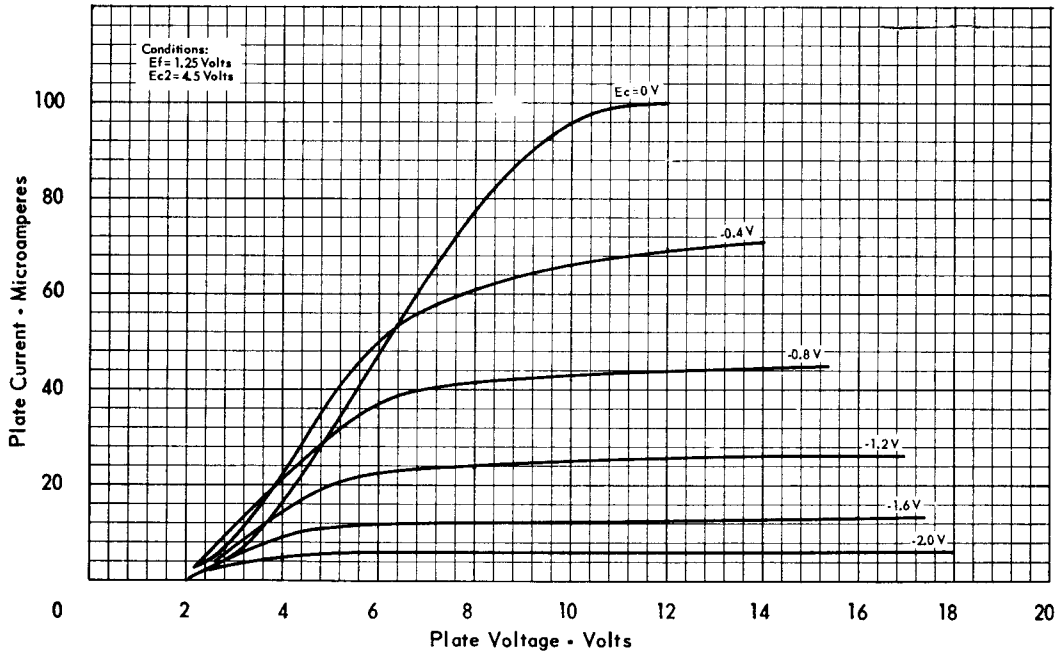

AVERAGE PLATE CHARACTERISTICS

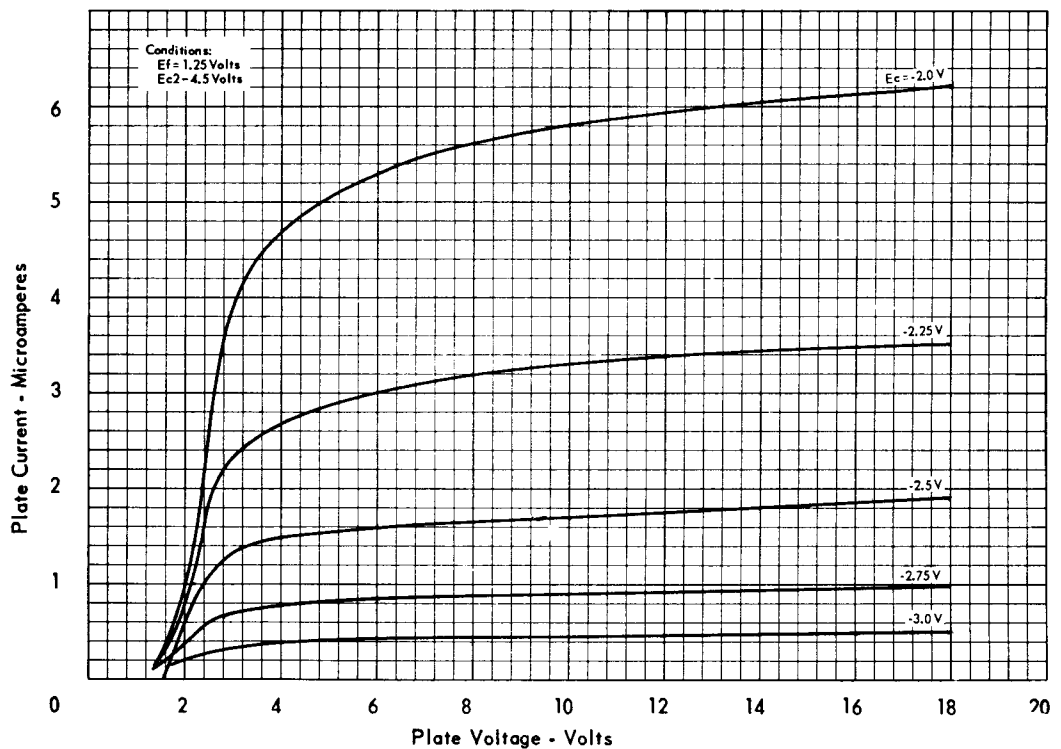

RAYTHEON MANUFACTURING COMPANY

RECEIVING TUBE AND SEMICONDUCTOR OPERATIONS



### SUBMINIATURE PENTODE

#### AVERAGE PLATE CHARACTERISTICS

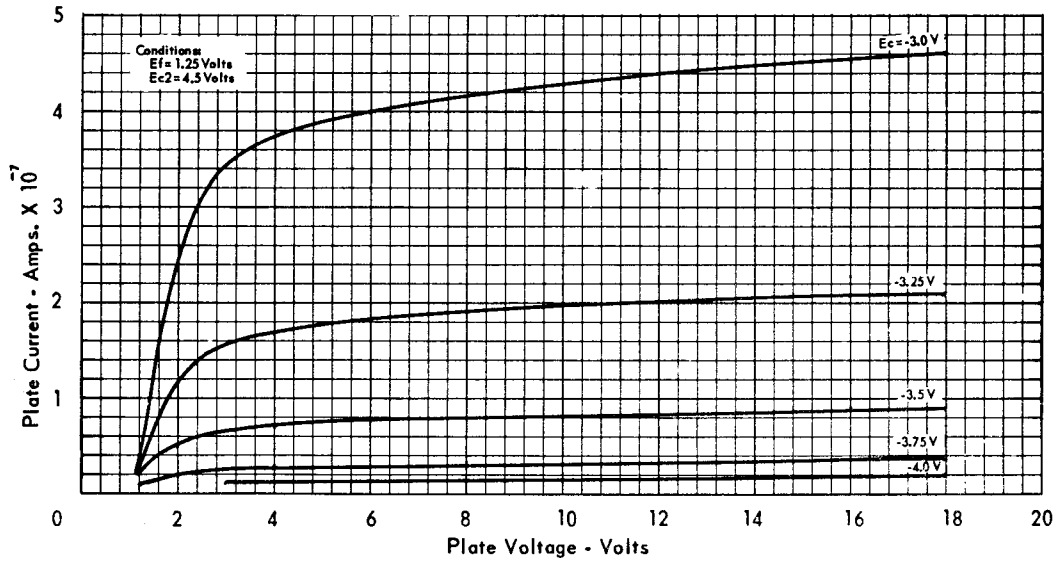

#### GRID CURRENT vs. GRID TO PLATE POTENTIAL Triode Connected (Control Grid Voltage)

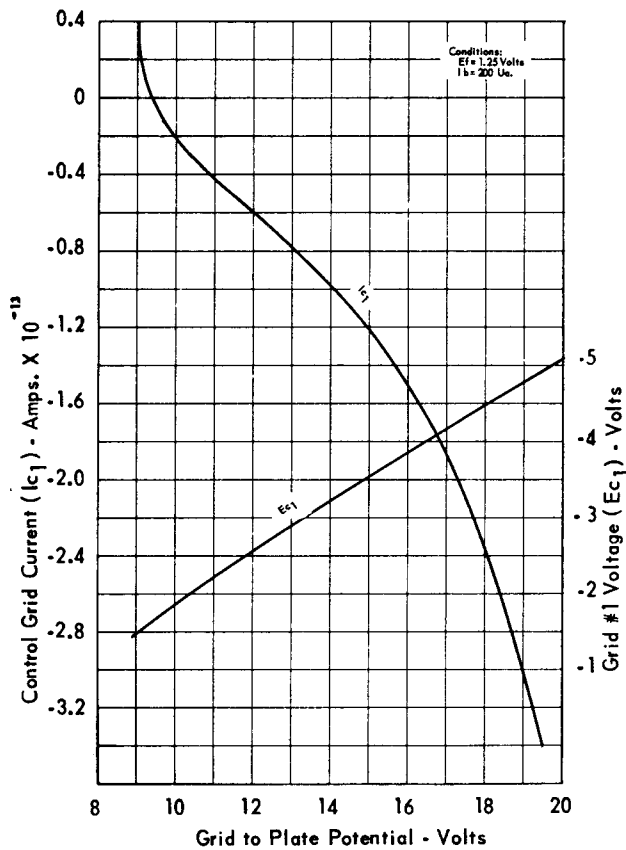

#### AVERAGE TRANSFER CHARACTERISTICS

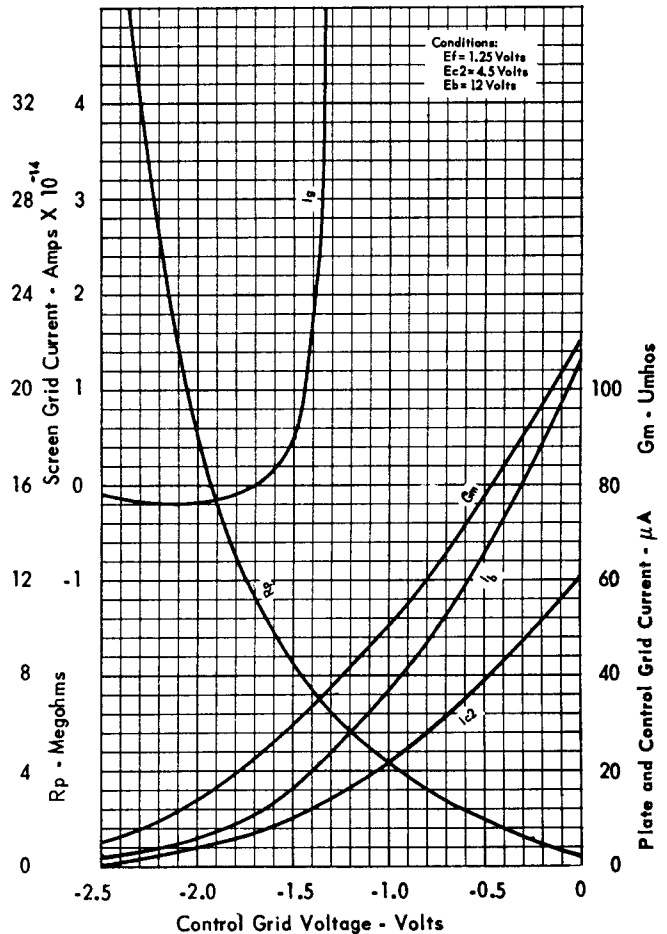



SUBMINIATURE PENTODE

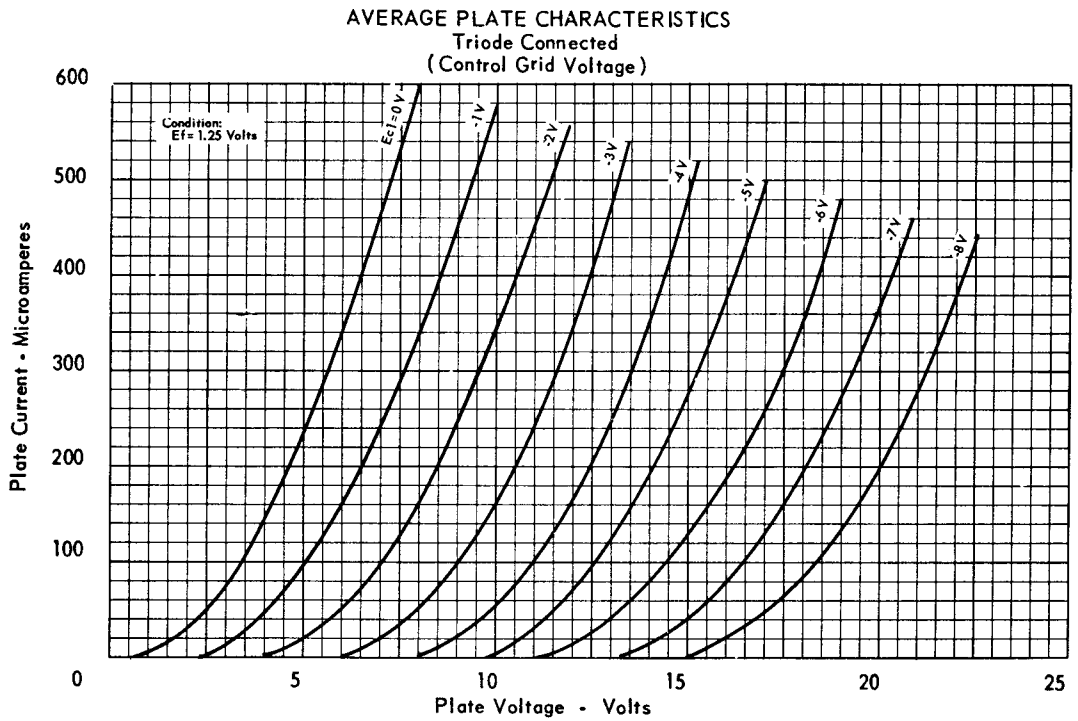

RAYTHEON MANUFACTURING COMPANY

RECEIVING TUBE AND SEMICONDUCTOR OPERATIONS