



Triode Type BR 137 B

HF AMPLIFIER AND OSCILLATOR

General. The BR 137B is a forced-air-cooled transmitting triode fitted with a tungsten filament.

Cooling. The anode requires forced air cooling. The air cooling and air flow characteristics given show the air inlet temperature °C/anode + grid loss; and air flow/air pressure. The temperature of the anode must not exceed 180°C.

The external grid and filament seals also require air cooling. The volume of air necessary is approximately 20 cu. ft. per minute, and should be directed on to the seals from above through a 1-in. nozzle. The temperature of the seals must not exceed 140°C.

All air cooling supplies must be in operation before the application of any supply voltage and should be continued, for at least one minute, after the removal of all supply voltages.

Filament Starting. The filament current must not exceed 622 A, even momentarily, at any time.

APPROXIMATE DATA

V_f	19.5	V
I_f	415	A
V_a (max)	15	kV
P_a (max)	20	kW
P_{gl} (max)	3	kW
μ (taken at V_a 6 kV, I_a 2 A)	43	
g_m (taken at V_a 10 kV, I_a 1.5 A)	35	mA/V
f (max) (at full ratings)	50	Mc/s
C_{a-gl}	50	pF
C_{a-k}	3	pF
C_{gl-k}	100	pF

Marked Voltage. Each valve is marked with the filament voltage required to give 45 A peak emission at 90% saturation.

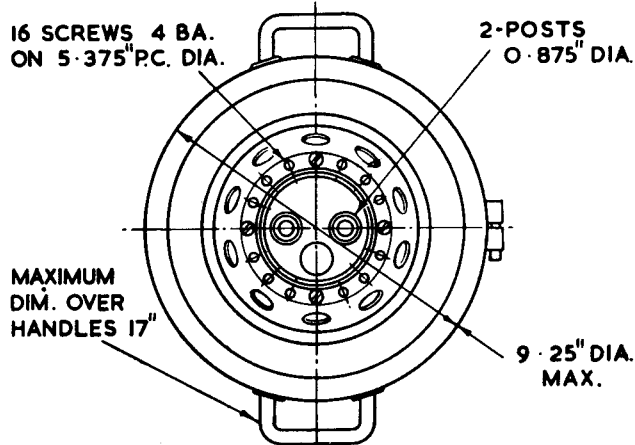
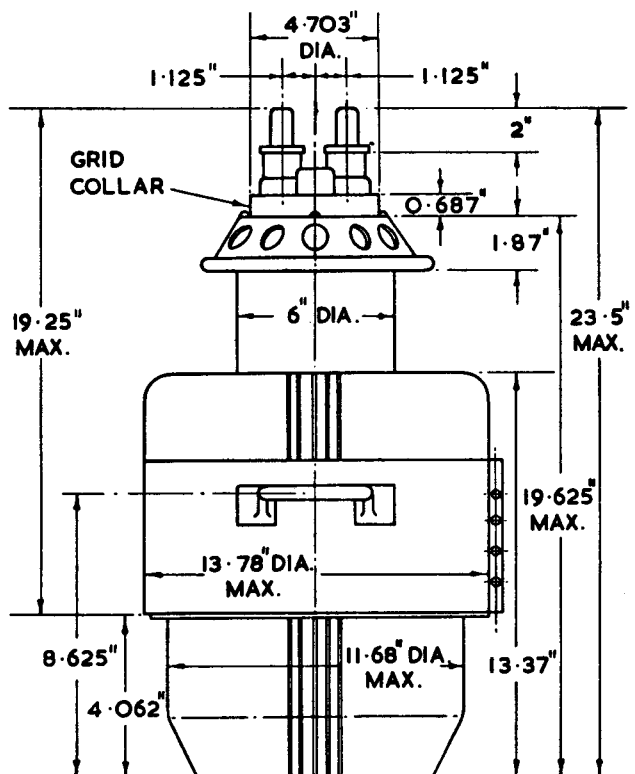

WEIGHT 196 lb. (89 kg.)

MARCONI'S WIRELESS TELEGRAPH COMPANY LIMITED

Head Office: Marconi House, Chelmsford, England. Telephone: Chelmsford 3221. Telegraphic Address: Expanse, Chelmsford

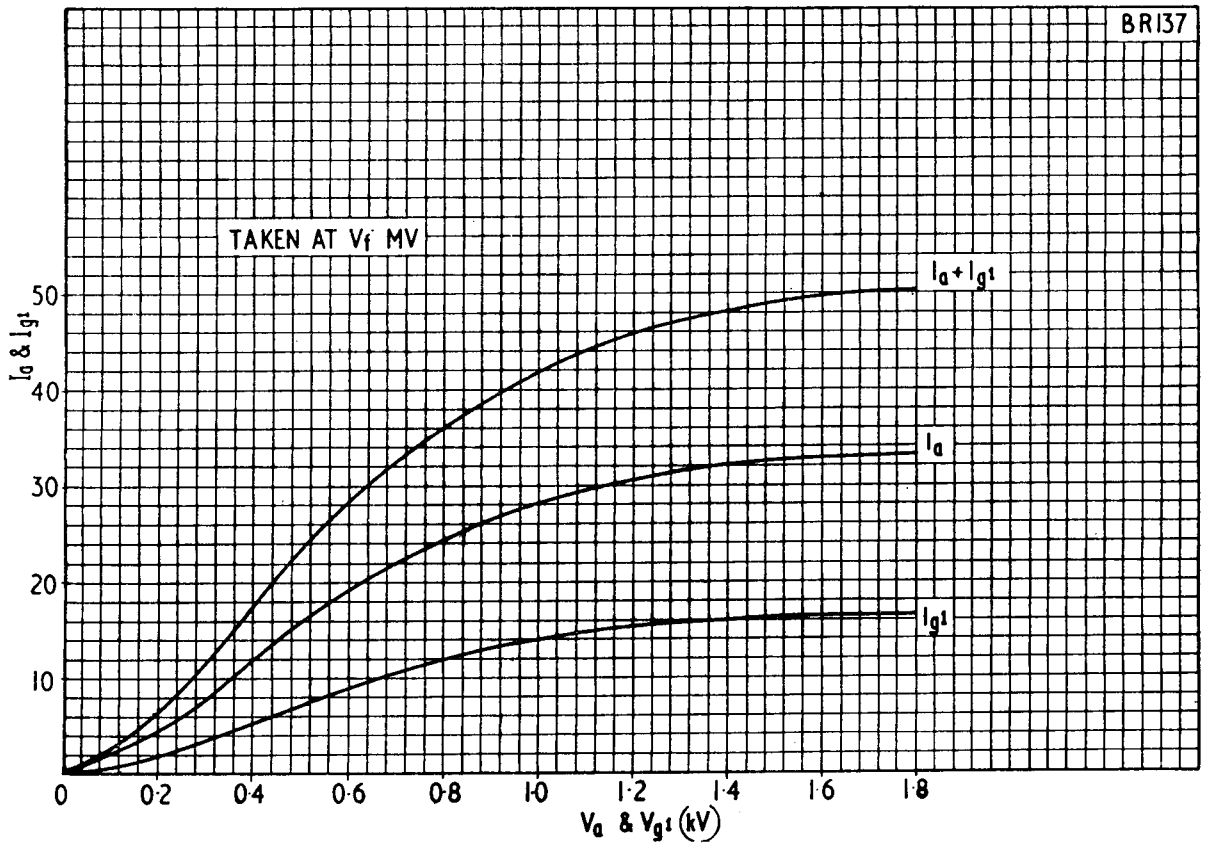
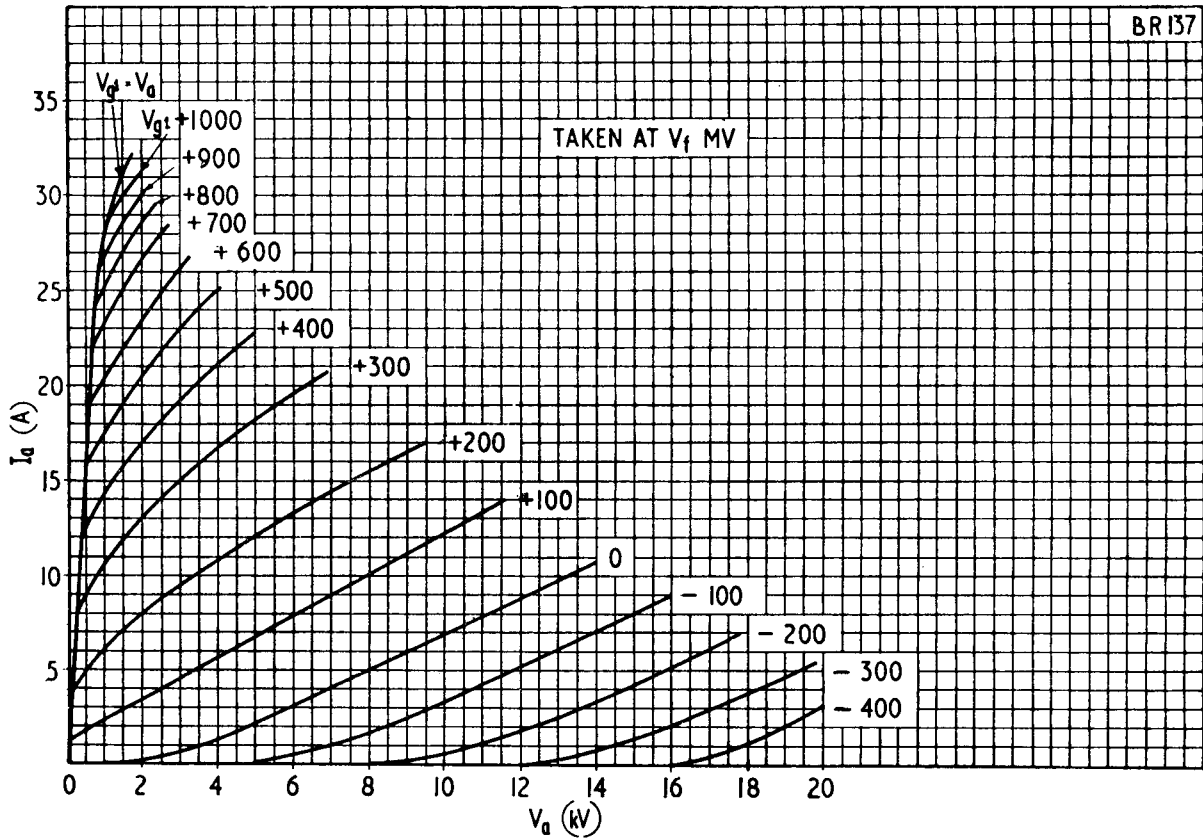

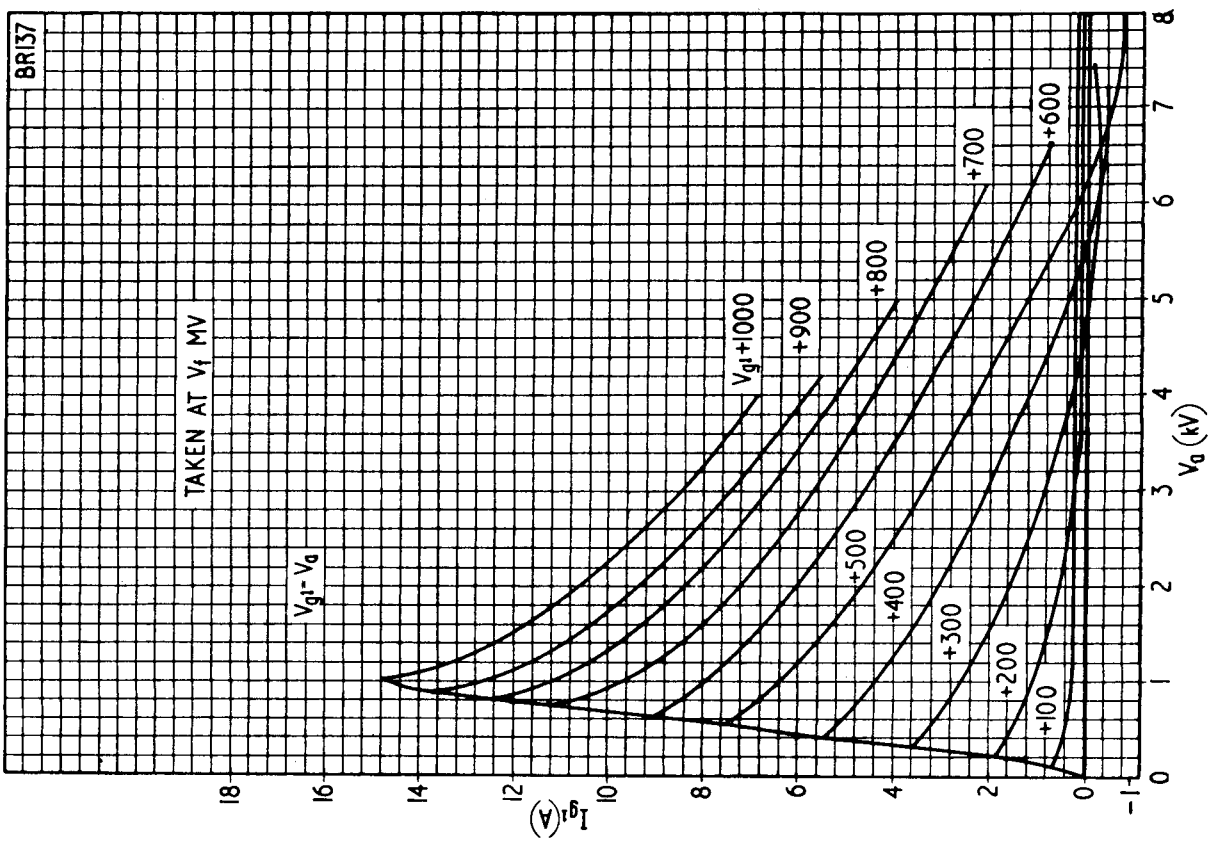
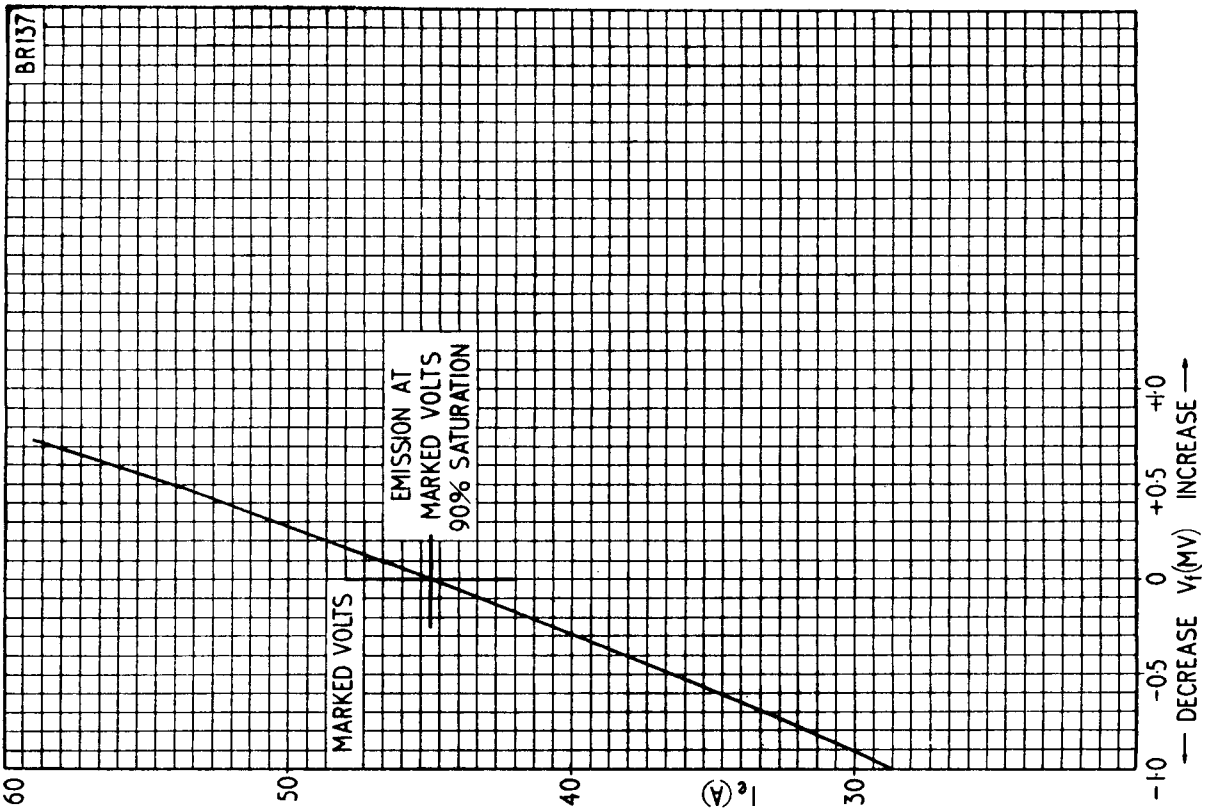

BR137

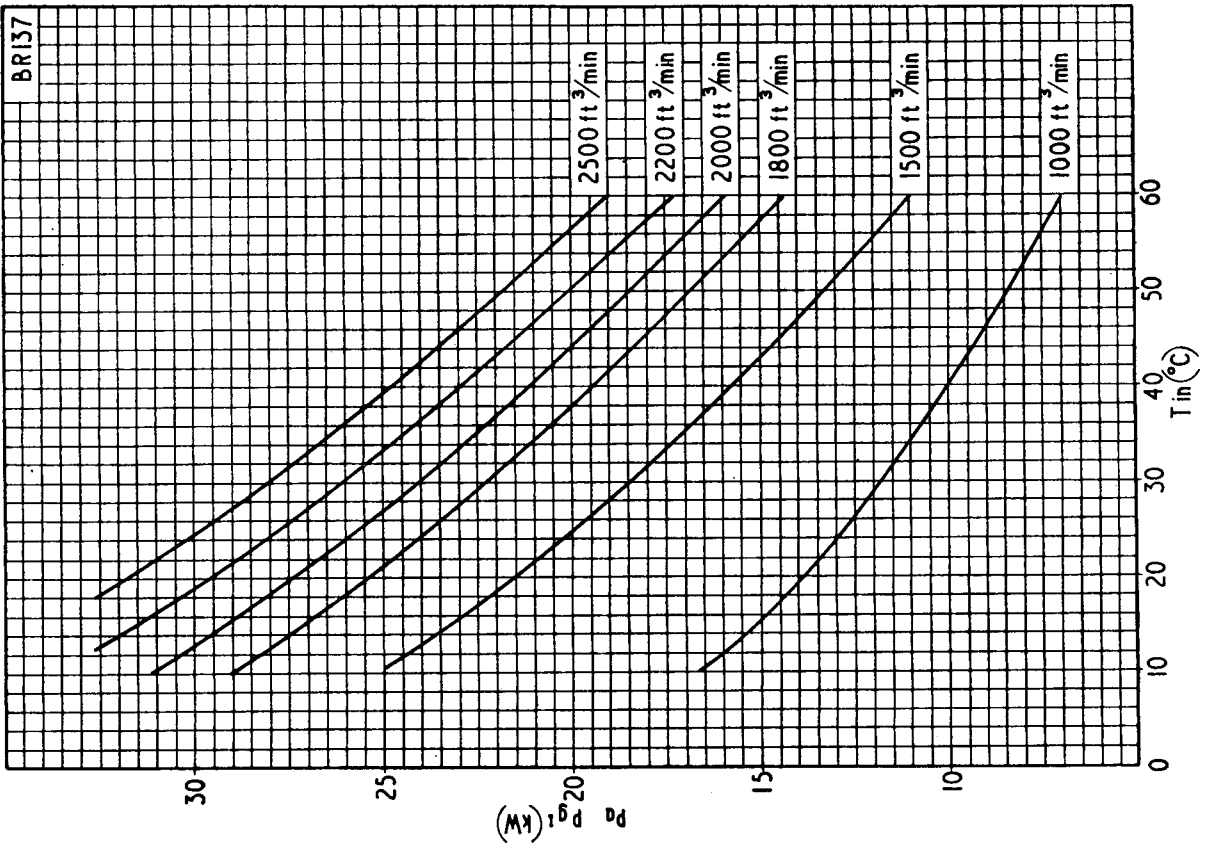

BR137

