



Half Wave Mercury Vapour Rectifier

2V/500C
(4049D)

4049D

CATHODE.

Oxide-coated shielded filament

Voltage	4	V
Nominal current	11	A

DIMENSIONS.

Maximum overall length	270	mm.
Maximum bulb diameter	63	mm.
Base	Giant Edison Screw	
Net weight	220	g.

MAXIMUM RATINGS.

Maximum peak inverse voltage	20	kV
Maximum peak anode current	5	A
Maximum average anode current	1.25	A
Condensed mercury temperature range with forced ventilation	20°C.-65°C.	

The above ratings apply to operation with a choke input filter and a supply frequency of 50 c/s.

MAXIMUM PEAK INVERSE VOLTAGE RATINGS.

Natural Ventilation	20°C.-55°C.	20°C.-40°C.
Forced Ventilation	20°C.-65°C.	20°C.-55°C.
Peak inverse voltage	Less than 10 kV	10kV to 20 kV

2V/500C
(4049D)

Half Wave Mercury Vapour Rectifier



4049D

TYPICAL OPERATION.

Circuit No.	No. of Valves	Maximum DC Output Volts	Maximum DC Output Amps.
2	2	6,400 V	2.5 A
3	4	13,000 V	2.5 V
4	3	9,500 V	3.75 V
5	6	9,500 V	7.5 V
6	6	18,500 V	3.75 V

This rectifier being indirectly heated, it is recommended that the output circuit be returned to the mid-point of the filament transformer secondary.

CATHODE HEATING TIME.

Ambient Temperature	10° to 15°	15° to 30°	above 30°
Min. pre-heating period	30 min.	15 min.	5 min.

After shipment or transit the valve must be pre-heated not less than 30 minutes before any anode voltage is applied so that the mercury may be distributed correctly. Temperature limits given under "Natural Ventilation" are only valid for unrestricted natural ventilation, forced air blast being required for operation up to the maximum condensed mercury temperature limit.

Note.—Before putting a valve of this type into service it is recommended that reference be made to the General Information Sheet K.



Half Wave Mercury Vapour Rectifier

2V/500C
(4049D)

4049D

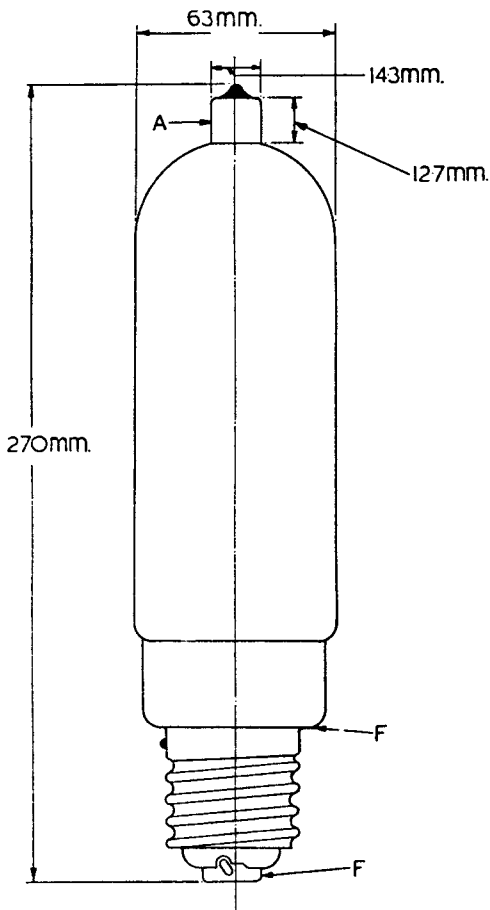

Tentative data
June 1946

2V/500C—3

2V/500C
(4049D)

Half Wave Mercury Vapour Rectifier



4049D

Circuit
No.
1

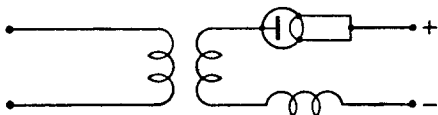

2

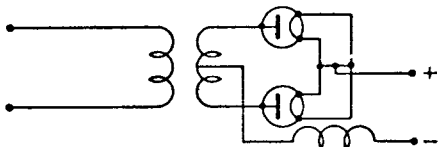

3

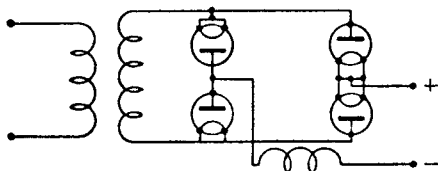

4

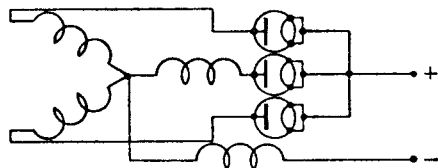

5

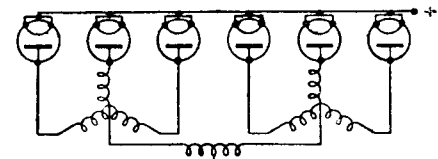

6

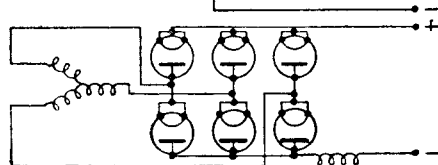

Tentative data
June 1946

2V/500C-4