



SUBMINIATURE VOLTAGE AMPLIFIER PENTODE

DESCRIPTION

The CK512AX is a filament type subminiature pentode designed primarily for use in resistance coupled audio frequency and direct coupled amplifiers. Typical applications are hearing aids and other wearable or portable instruments. The tube features low battery drain, long life, small size and low microphonic level. The tinned flexible leads may be soldered or welded directly to circuit components without the use of sockets. Standard subminiature sockets may be used by cutting the leads to 0.20" length. The suppressor grid consists of two beam-forming detector plates.

MECHANICAL DATA

ENVELOPE: T-2X3 Glass

BASE: 0.016" tinned flexible leads with a length of 1.5" minimum and a center-to-center spacing of 0.05".

TERMINAL CONNECTIONS: (Red dot is adjacent to Lead 1)

- Lead 1 Plate
- Lead 2 Grid #2
- Lead 3 Filament, positive
- Lead 4 Grid #1
- Lead 5 Filament, negative

MOUNTING POSITION: Any

WEIGHT: 0.07 ounces

ELECTRICAL DATA

DIRECT INTERELECTRODE CAPACITANCES: (uufds.) *

Grid to Plate	0.045
Input	2.0
Output	1.5

RATINGS:

Filament Voltage	0.625 volts
Absolute Maximum Filament Voltage	0.78 volts
Maximum Plate Voltage	45 volts
Maximum Grid #2 Voltage	45 volts

AVERAGE CHARACTERISTICS:

Filament Voltage	0.625 volts
Filament Current	20 ma.
Plate Voltage	22.5 volts
Grid #2 Voltage	22.5 volts
Grid #1 Voltage	-0.625 volts
Plate Current	125 ua.
Grid #2 Current	40 ua.
Transconductance	160 umhos
Plate Resistance	1.25 megohms

TYPICAL OPERATION IN RESISTANCE COUPLED AUDIO FREQUENCY AMPLIFIER:

	First Stage		Second Stage	
Filament Voltage	0.625	0.625	0.625	0.625 volts
Plate & Grid #2 Supply Voltage	15	22.5	15	22.5 volts
Grid #1 Voltage **	0	0	-0.625	-0.625 volts
Plate Resistor †	1.0	1.0	1.0	1.0 megohms
Grid #2 Resistor †	2.2	2.7	1.0	1.5 megohms
Average Voltage Gain (G1 to P) ††	26:1	37:1	22:1	33:1
Approx. Voltage Gain (G2 to P)	3:1	4:1	3:1	4:1

* Measured without shielding of bulb.

** Control grid should be returned through approximately 5 to 22 megohms to negative filament or bias voltage.

† Other plate and grid #2 resistor values may be used to obtain less variation in voltage gain between tubes at the possible expense of less average gain.

†† The values of voltage gain are quoted for a coupled load of 5 megohms, zero source impedance, and a 5 megohm grid resistor. The reactive impedances (Cin, Cout, Cg1, Cg2, CL) are of such values that they have negligible effect upon the gain. See CS-2472-12 on page 4.

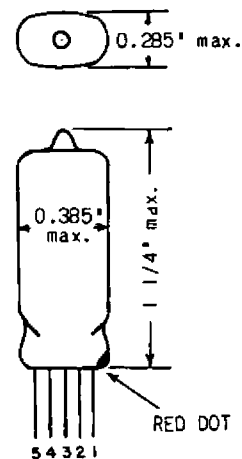

VIEW FACING TYPE NUMBER



SUBMINIATURE VOLTAGE AMPLIFIER PENTODE

AVERAGE PLATE CHARACTERISTICS

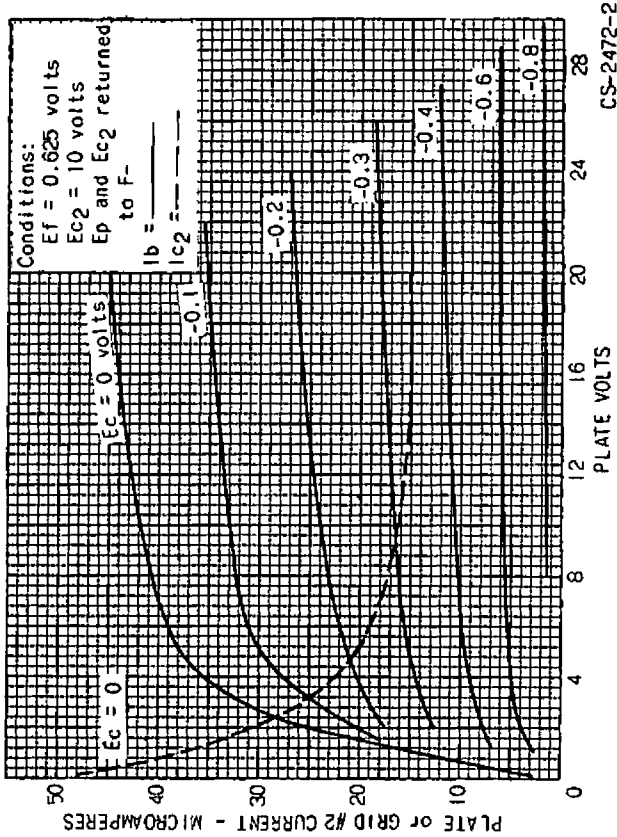

AVERAGE PLATE CHARACTERISTICS

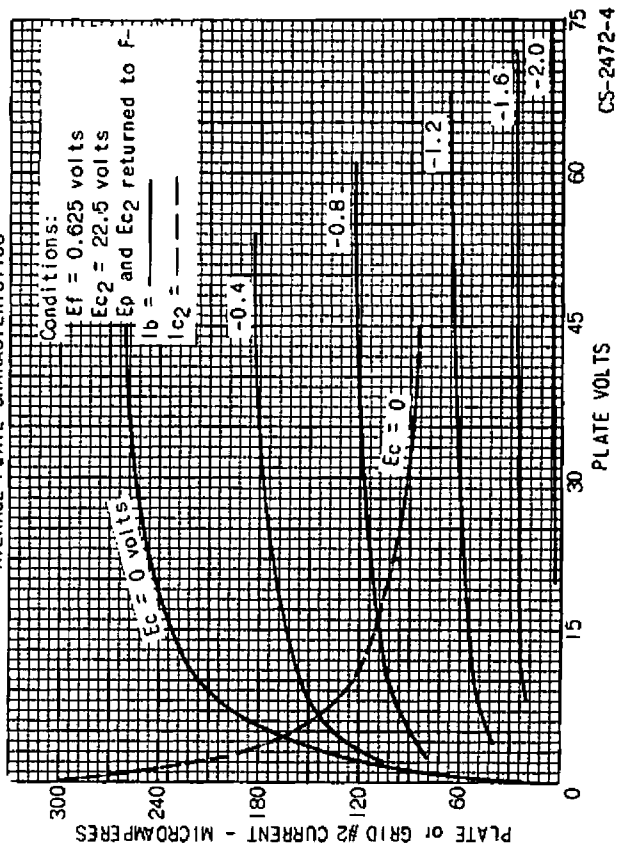

AVERAGE PLATE CHARACTERISTICS

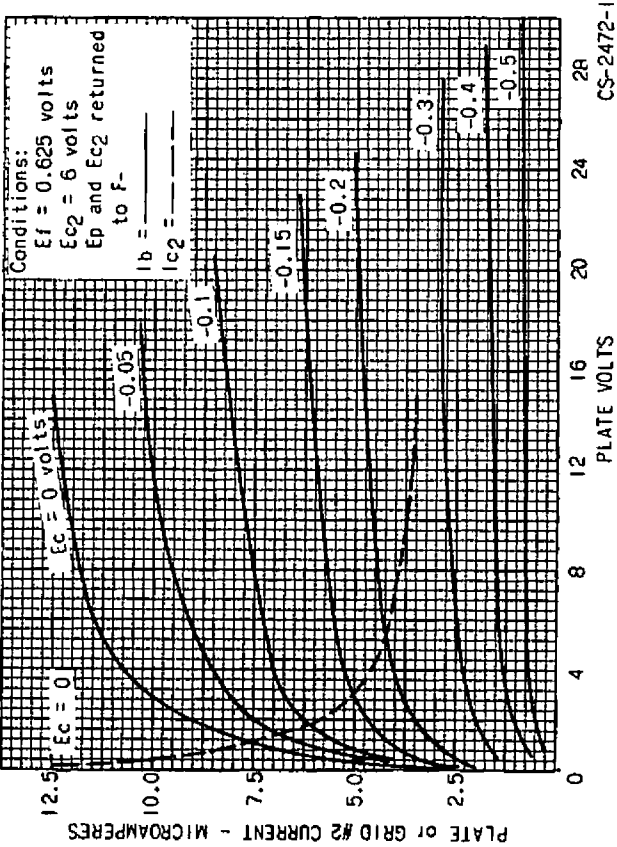

AVERAGE PLATE CHARACTERISTICS

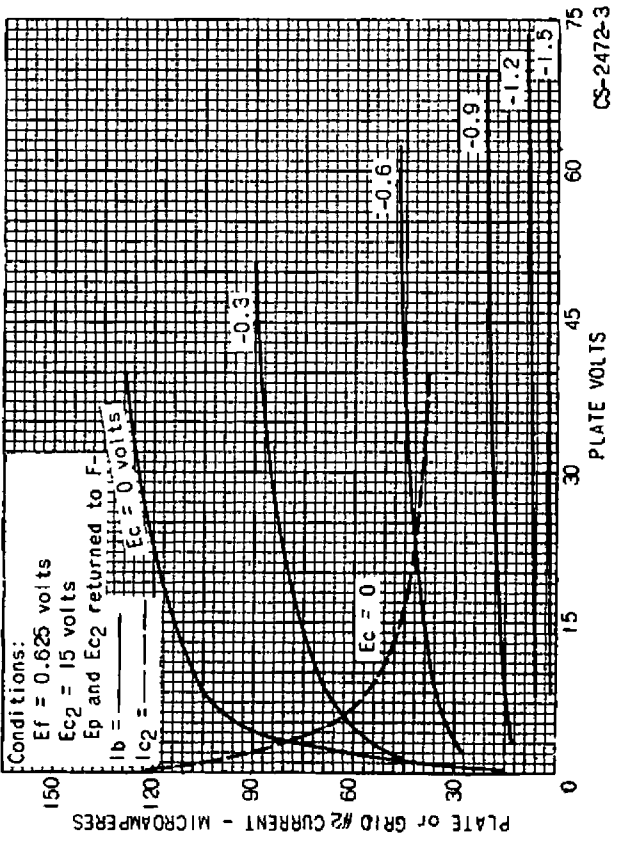



SUBMINIATURE VOLTAGE AMPLIFIER PENTODE

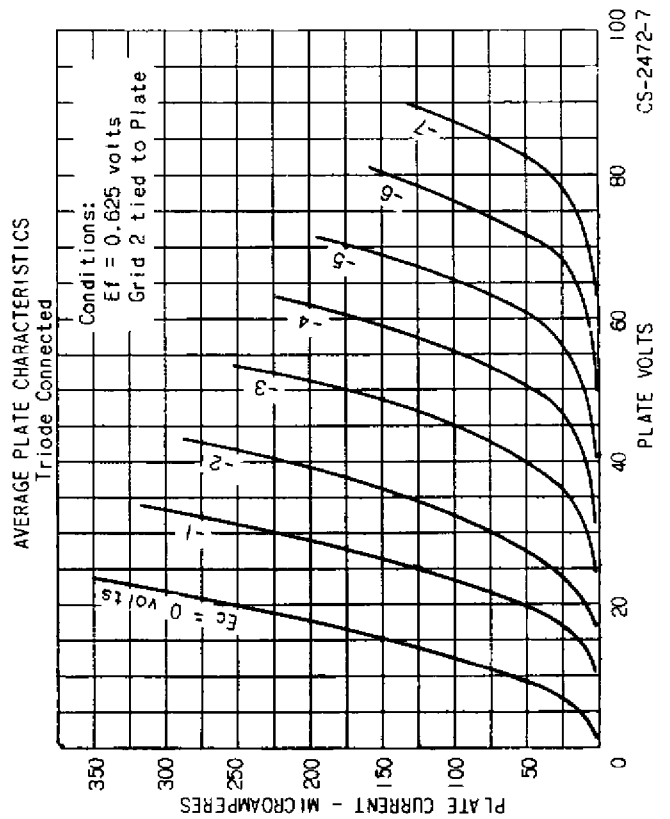
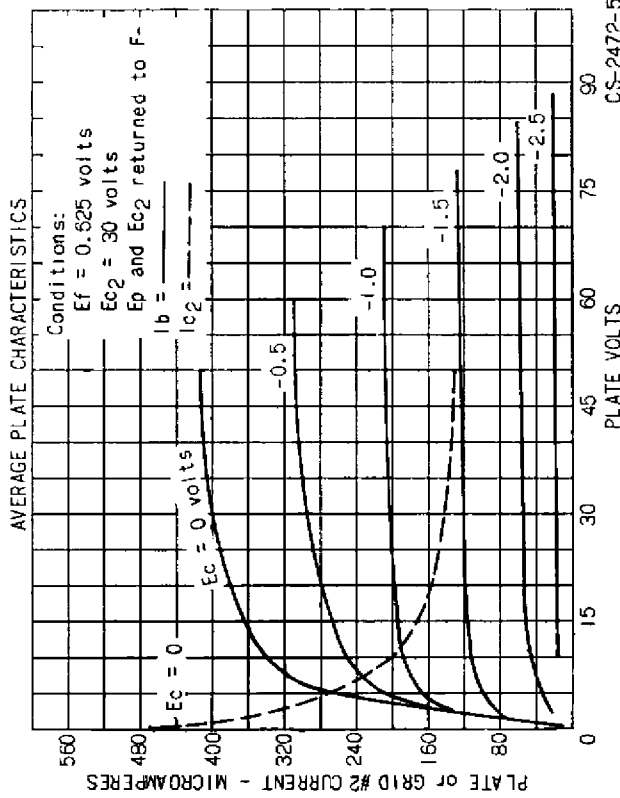
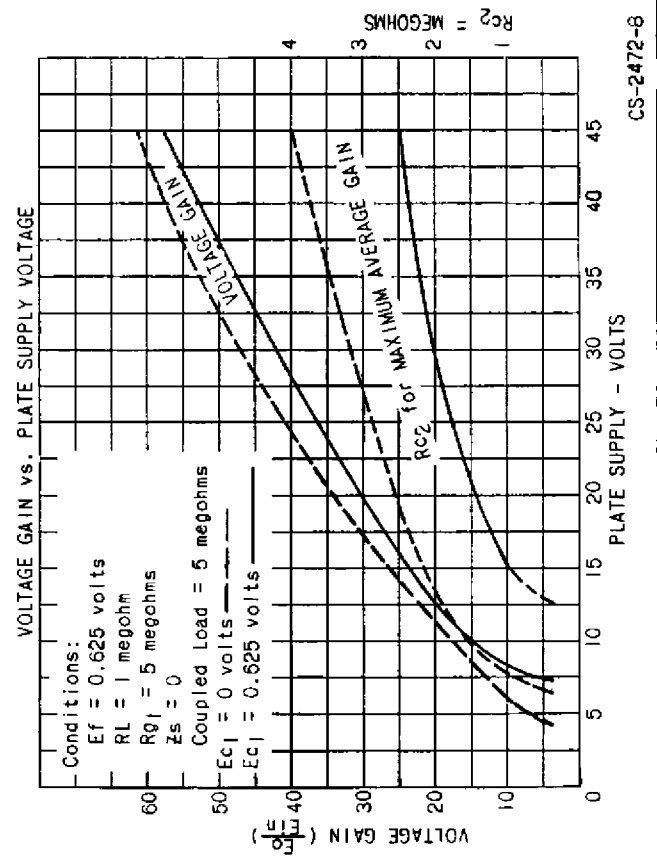
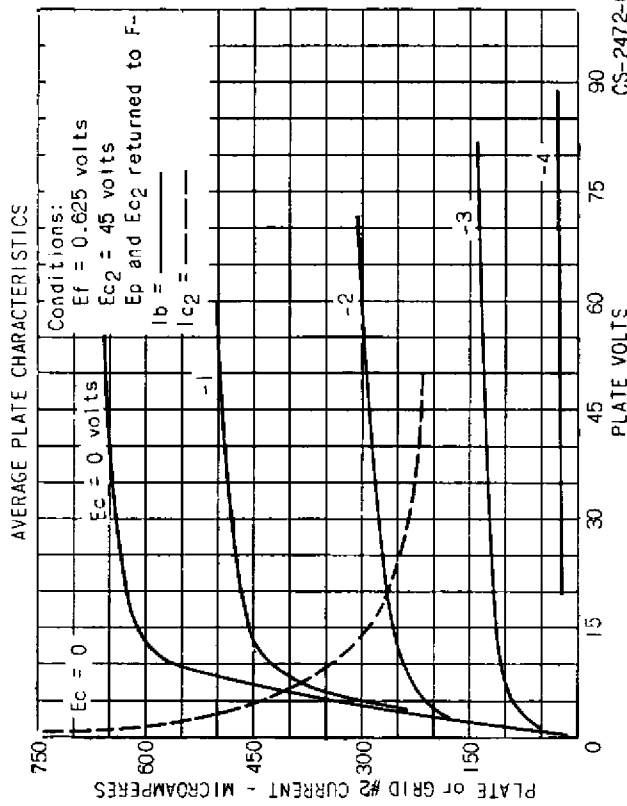



SUBMINIATURE VOLTAGE AMPLIFIER PENTODE

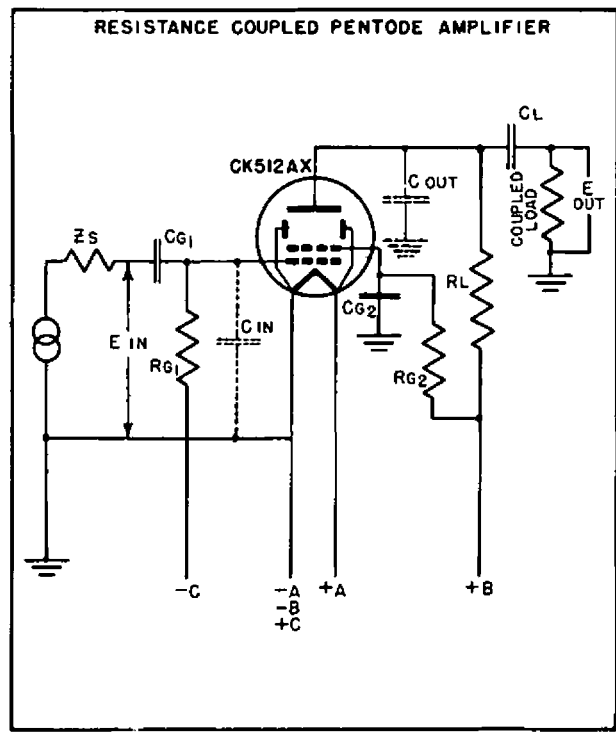
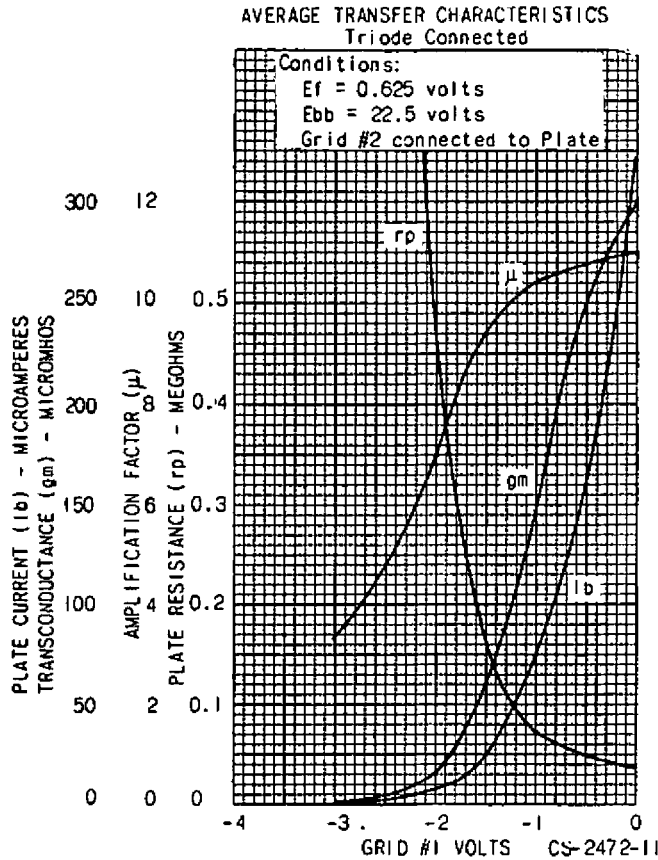
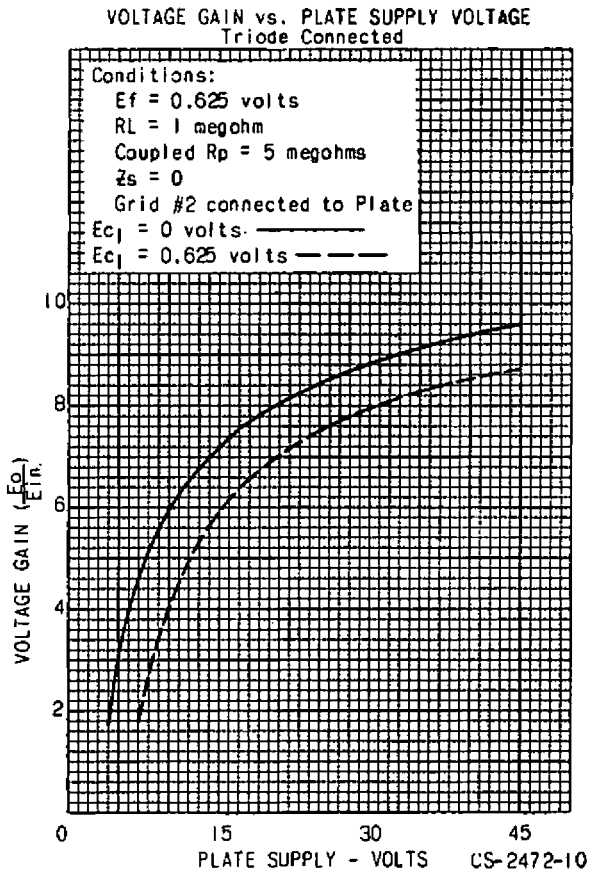
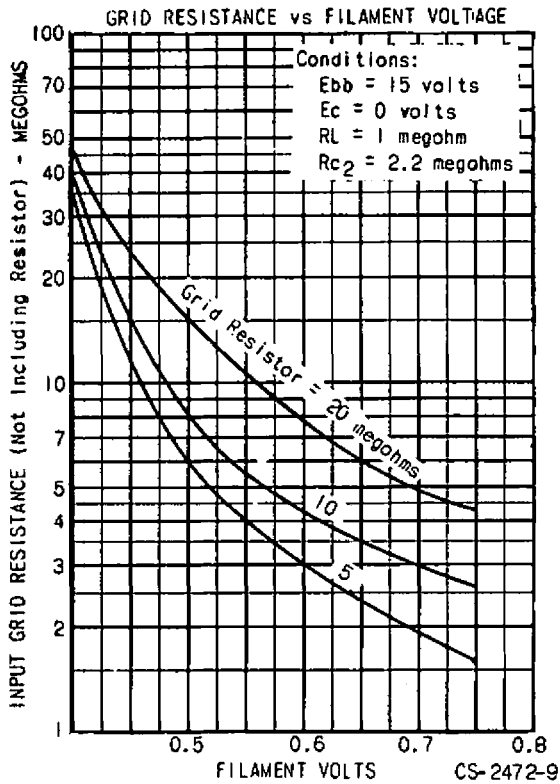

CS-2472-12

Raytheon Subminiature tubes are made under one or more of the following United States patents owned by Raytheon: 1,963,008; 2,330,838; 2,366,220; 2,376,397; 2,406,422; 2,413,338; 2,266,080; 2,355,083; 2,358,829; 2,366,756; 2,402,797; 2,467,390.