



Excellence in Electronics

**TYPE
RK6390**

The type RK6390 is a reflex velocity variation oscillator designed for use with a coaxial cavity in CW or pulsed operation over the 6700 to 11050 Mc range with an average power output of 60 milliwatts. Freely circulating and in some cases forced air is required for cooling of the grid ring cavity contacts. The extremely wide frequency range of this tube makes it ideally suited for signal generator and special local oscillator applications. A special control electrode facilitates low-voltage, pulsed modulation.

GENERAL CHARACTERISTICS

ELECTRICAL

Heater Characteristics

Heater Voltage	6.3 ± 0.5V
Heater Current	0.58 A

Ratings — Absolute Maximum Values

Resonator Voltage	1250 Vdc
Resonator Current	20 mAdc
Reflector Voltage	
Minimum Negative Value	—50 Vdc
Maximum Negative Value	—700 Vdc
Control Electrode Voltage	±25 V
Control Electrode Current	6 mA
Reflector Current	1 mAdc
Heater-Cathode Voltage	±50 V
Dissipation (Exclusive of Heater Power)	25.5 W
Temperature of G ₃ Sleeve	160°C

Typical Operating Conditions (CW)

Coaxial Cavity	Special Design Required
Reflector Mode	3¼, 4¼ cycles
Cavity Mode	¼ wavelength
Frequency Range	7000-11000 Mc
DC Resonator Voltage	1250 Vdc
DC Resonator Current (exclusive of control electrode current)	20 mA
DC Reflector Voltage Range*	—140 to —375 Vdc
DC Reflector Current	0 mA
DC Control Electrode Voltage*	+2 to +16 Vdc
DC Control Electrode Current	5 mA (max.)
Control Electrode Cutoff Voltage	—3 to —23 Vdc
Power Output (Average CW)	60 mW
Power Output (Minimum CW)	45 mW
Electronic Tuning (Half Power) † Bandwidth	12 Mc (min.)
Reflector Modulation Sensitivity @ 8340 Mc	0.1 Mc/Volt
Thermal Compensation (Tube Without Cavity)	0.1 Mc/°C

* Adjusted for maximum power output.

• Adjusted for 20 milliamperes resonator current.

† Change in frequency between the two ½ power points when the reflector voltage is varied above and below the point of maximum power output corresponding to the given frequency.

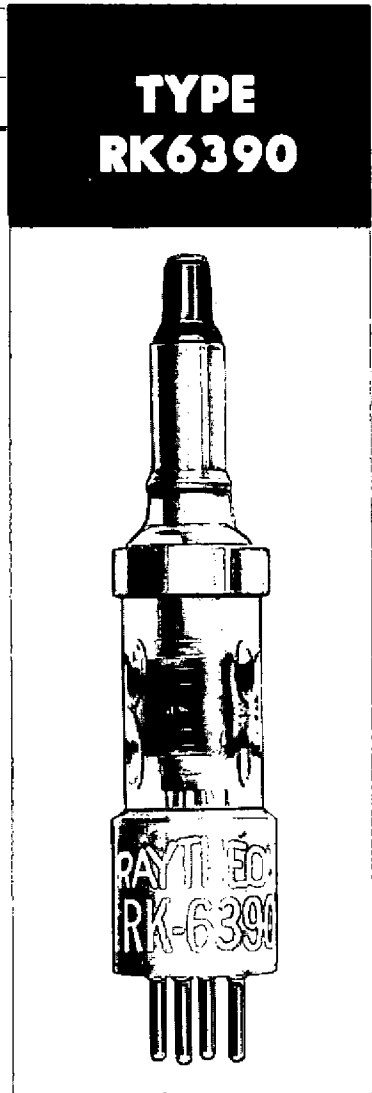



Typical Operating Conditions (Pulsed)

Pulse Repetition Rate	40-4000 pps
Pulse Duration (Minimum)	0.5 μ s
Rise Time	0.1 μ s
Fall Time	0.1 μ s
Beam Current During Off Time	10 μ a

The general conditions for pulsed operation are the same as those given above for CW operation. Power output for pulsed operation will not be less than 1.5 db below the power output for CW operation over the band.

General Mechanical Characteristics

Mounting Position	Any
-----------------------------	-----

Over-all Dimensions	See Outline Drawing
Envelope	Glass
Seals	Glass to Copper Oxide
Banana Jack	Required Ucinite #152005 Mating Plug or Equivalent.
Base	Special Miniature 4 Pin, Fits Amphenol #78-545 Socket.
Vibration	10 G @ 50 cps
Altitude	50,000 ft (max.)

DETAILED ELECTRICAL INFORMATION

REFLECTOR

The reflector electrode is connected to the small banana jack on the top of the tube. Reflector voltages more positive than -50 volts with respect to the cathode may result in damage to the tube. Under conditions of vigorous oscillation and light loading, excessive reflector current may be drawn (in the order of one milliampere) on the long wavelength of the band. No damage will result, however, except in cases where the heavy reflector current flowing in a high reflector circuit impedance causes the reflector potential to swing increasingly positive with respect to the cathode. Where high reflector circuit impedances are used, it is advisable to shunt the reflector and cathode with a small diode to prevent the reflector from swinging positive.

CATHODE

In most applications, the metal cavity used with the RK6390 is operated at ground potential, and the cathode will be negative with respect to ground by the amount of this resonator potential. The cathode may be connected to one side of the heater or to the center tap of the heater transformer secondary. When the cathode and heater are con-

nected together, connections to the cathode should be made directly to the cathode contacts on the tube socket and never to a heater lead. When the cathode and heater are not tied together, the heater-cathode voltage should not exceed ± 50 volts. In all cases where the resonator is operated at ground potential, the heater transformer must be insulated to withstand the maximum resonator voltage. Maximum tube life will be realized if a 30-second heater warmup period precedes the application of other voltages. The beam potential must never be applied before any other voltages.

CONTROL ELECTRODE

In applications where the RK6390 is to be used in both CW and pulsed operation, the circuit in Fig. 1 is recommended. With the selector switch in the CW position, the 6J6 is effectively out of the circuit and the bias on the RK6390 is set at a value that will yield a 20-milliampere beam current. With the selector set at the pulsed position, the 6J6 shunts the lower portion of the potentiometer and the voltage division is such that the RK6390 is biased to cutoff. A negative pulse of suitable amplitude applied to the grid of the 6J6 will drive it to cutoff and restore the grid of the RK6390 to the level set for CW operation.

VELOCITY VARIATION OSCILLATOR

ELECTRONIC TUNING

Vernier adjustment of the frequency of the RK6390 is accomplished by varying the reflector voltage. If the mechanical tuning mechanism employed in the external cavity and the reflector voltage are mutually adjusted to yield a maximum power output at a given frequency, and if then the reflector voltage is varied above and below the value for maximum power such that the power output is reduced to one half, the frequency change between the half power values is defined as the electronic tuning range. The range of electronic tuning and the linearity of its variation with reflector voltage is a function of the type of load and coupling used. Maximum electronic tuning range will be achieved with operation into a resistive load. Operation into a highly reactive load may be attended by excessive hysteresis, and non-linear variation of frequency with reflector voltage.

FREQUENCY STABILITY

The regulation of the voltages applied to the reflector, resonator, and control grid will be reflected directly in the stability of the output frequency. Hence, the regulation of those voltage supplies must be commensurate with the stability requirements of the application.

The thermal frequency drift experienced with the RK6390 depends mainly on the changes in physical size of the resonant chamber with temperature. The RK6390 is temperature-compensated so that thermal coefficient of frequency drift will

not exceed 0.1 Mc/°C when operating in a constant size cavity. The amount by which the frequency drift exceeds 0.1 Mc/°C is therefore dependent only on the thermal properties of the cavity. Careful consideration should be given to the material from which the external cavity is constructed.

MODE OF OPERATION

The RK6390 is designed for operation with contacting or noncontacting plunger-type coaxial cavities over the 6700 to 11050 Mc band in the 3¼ and 4¾ reflector modes. Design and construction of the above-mentioned cavities can be extremely troublesome, and certain design precautions must be observed to avoid interference from circumferential resonances, one-quarter wavelength modes, and multifrequency bunching. An extensive treatment of the design of wide-range coaxial cavities is beyond the scope of this publication; however, the following references contain adequate information pertinent to their design.

1. W. H. Huggins. "Multifrequency Bunching in Reflex Klystrons," Proc. I.R.E., XXXVI, 624-30.
2. W. H. Huggins. "Broad Band Non-Contacting Short Circuits for Coaxial Lines," Proc. I.R.E., XXXV, 1324-28.
3. Radio Research Laboratory Staff. "Very High Frequency Techniques." New York: McGraw-Hill, 1947, II, 916-19 and 900-11.

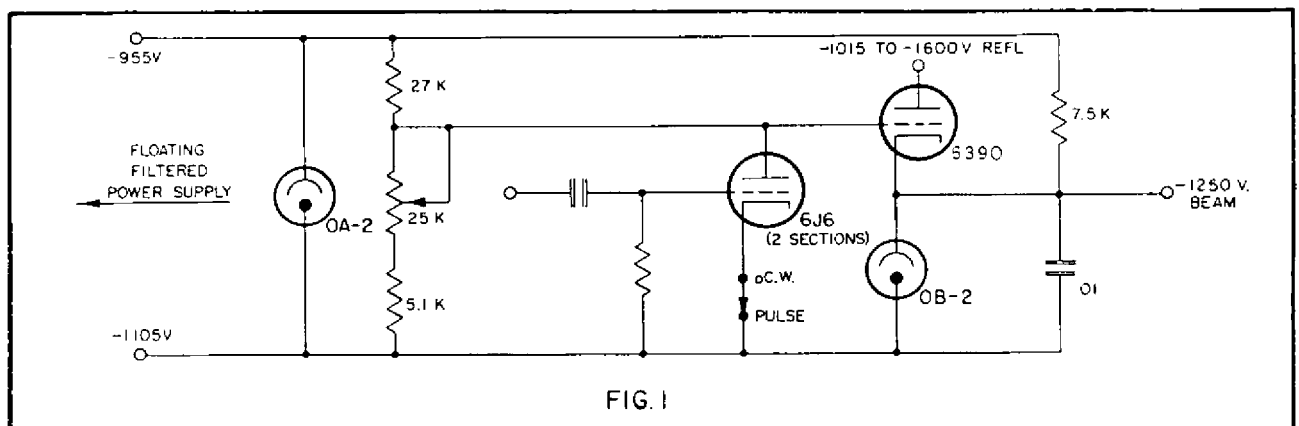

FIG. 1



DETAILED MECHANICAL INFORMATION

INSTALLATION

The tube mounts in any position and requires a special, miniature, 4-prong socket such as an Amphenol Type 78-545 or low-loss equivalent. Clamping to the G_2 ring should be made in such a manner that no mechanical strain be set up in the glass between G_2 and G_3 rings. A toroidal spring contact between the cavity and the G_2 ring, as shown in Fig. 2, is recommended.

Temperatures of the G_3 sleeve in excess of 160°C cannot be tolerated; and in cavities where center conductor conduction is insufficient to hold this tolerance, forced-air cooling is required. In general, the center conductor of wide-range coaxial cavities will have sufficient mass to provide adequate conduction. However, in situations

where conduction is inadequate, a center conductor made of coin silver will improve conduction sufficiently to obviate forced-air cooling.

Optimum broad-band operation is best achieved with a load termination of 50 ohms and VSWR'S not greater than 1.25/1.

SHIELDING

Operation of the RK6390 in the presence of strong magnetic fields usually requires shielding of the resonator and reflector leads to avoid undesirable modulation of the tube output. In extremely troublesome environments, it may be necessary to place the parts of the RK6390 not covered by the cavity in a metal chamber with poly-iron chokes provided on the leads bringing the voltages into the chamber.

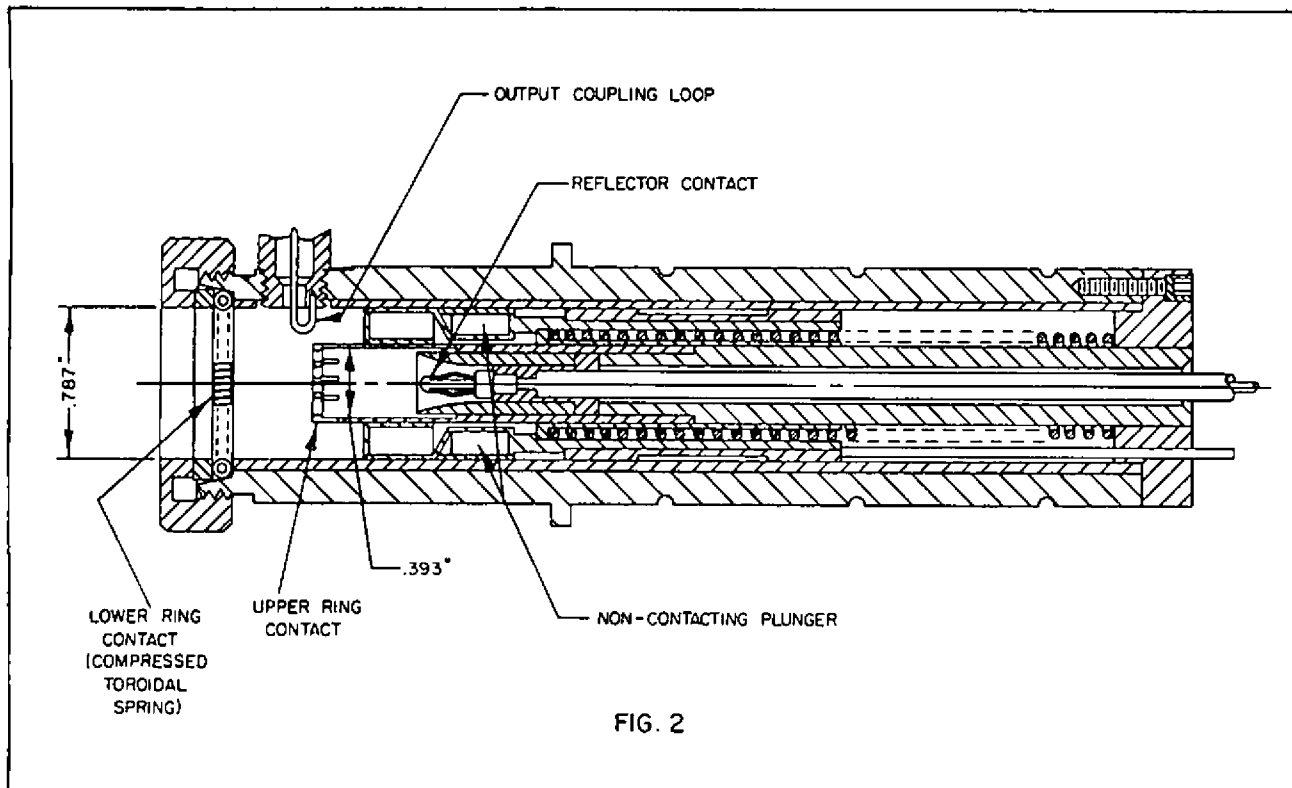



VELOCITY VARIATION OSCILLATOR

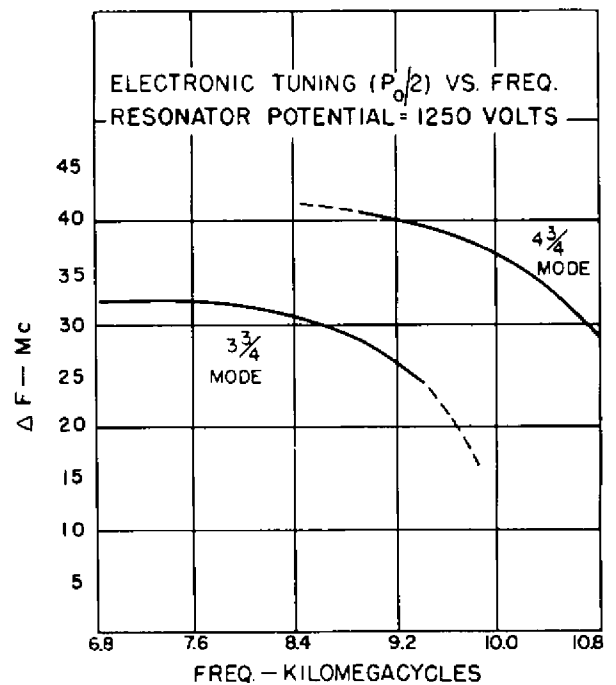
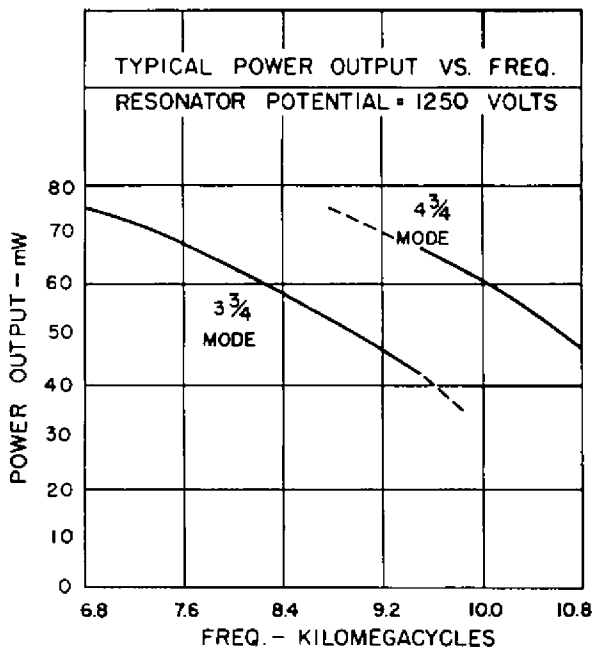
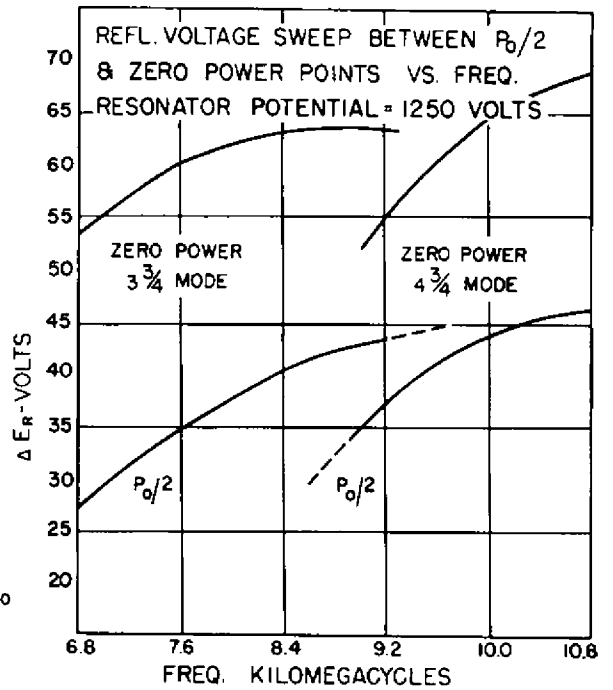
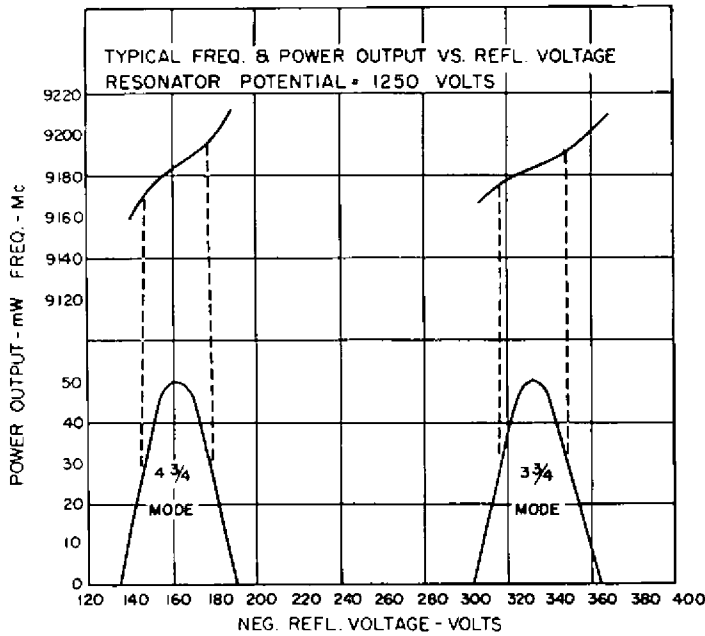

RAYTHEON MANUFACTURING COMPANY
MICROWAVE AND POWER TUBE OPERATIONS



TYPE RK6390

VELOCITY VARIATION OSCILLATOR

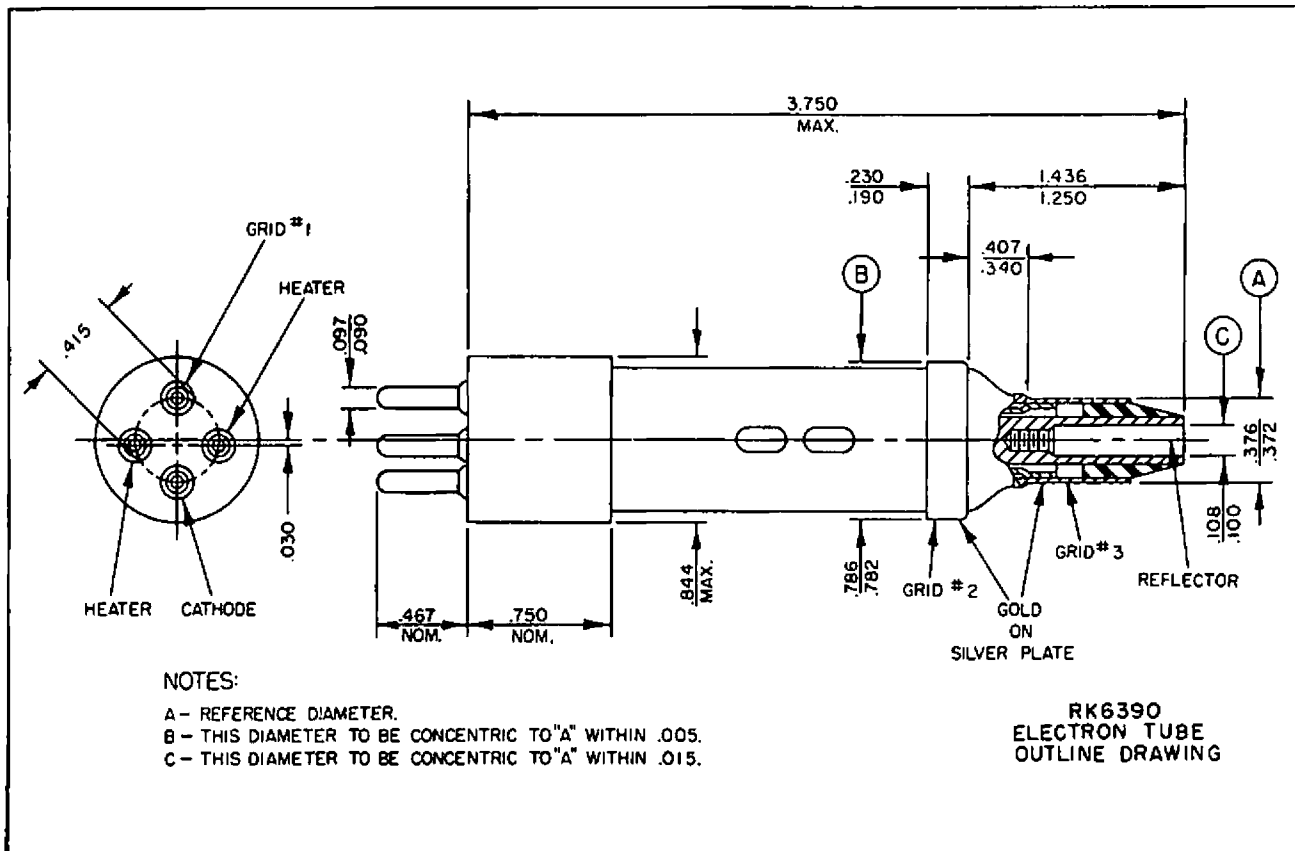
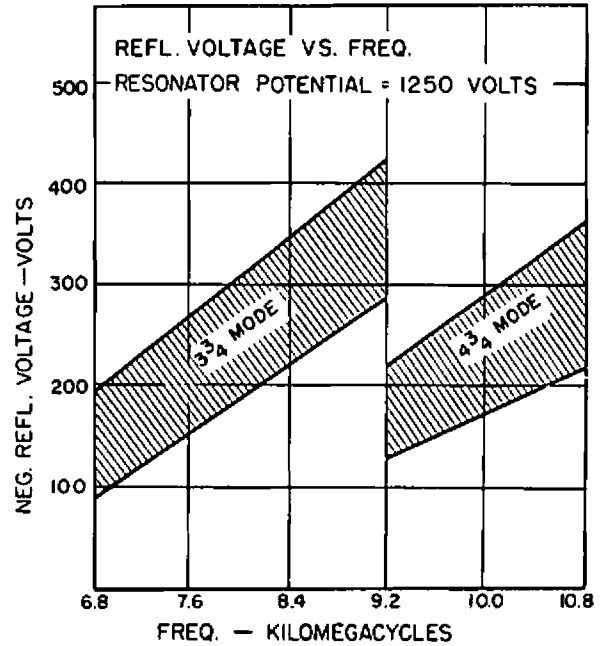
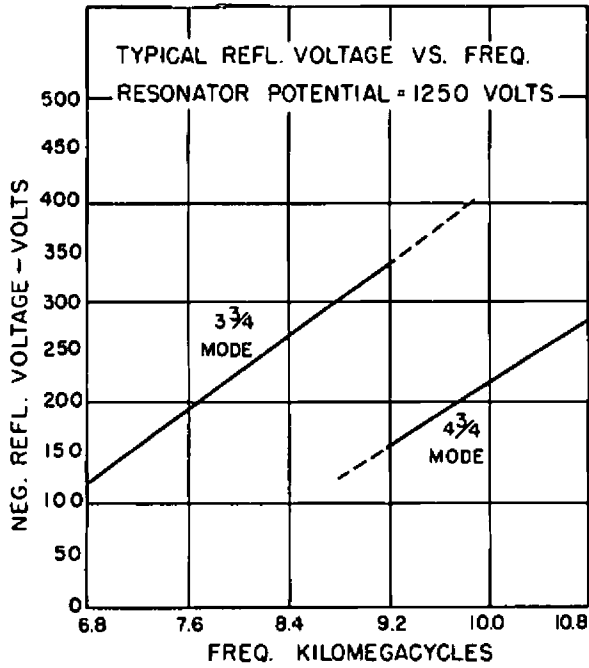

RAYTHEON MANUFACTURING COMPANY
MICROWAVE AND POWER TUBE OPERATIONS