

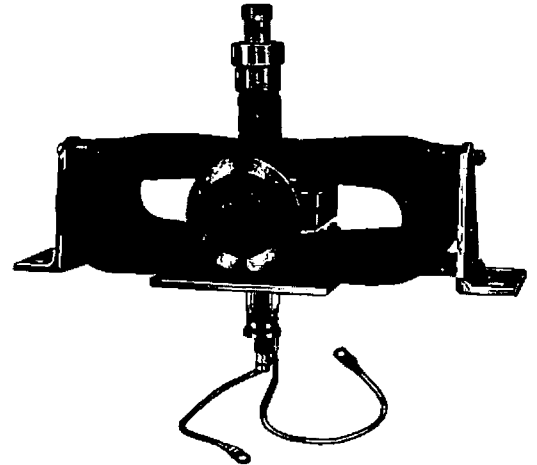

*Excellence in Electronics*

**TYPE  
RK7156**

The RK-7156 is a mechanically tunable magnetron designed for pulsed operation in the frequency range 5450 to 5825 megacycles. It is an integral magnet type tube rated for a minimum peak power output of 250 kilowatts. Forced air cooling over fins integral with the anode block is required, and output coupling is made to standard 1 x 2 inch waveguide. Tuner construction facilitates rapid hand or motor tuning to any desired frequency within the specified range.



**TUNABLE  
PULSED-TYPE  
MAGNETRON**

**GENERAL PRECAUTIONS**

Reliable operation and maximum magnetron life can be achieved only if the overall radar transmitter is designed with the magnetron characteristics and peculiarities clearly in mind. There are many problems peculiar to magnetrons in general which must be given special consideration in system design. These problems are discussed in detail on the following pages. If for any reason it is desired to operate the RK-7156 under conditions other than those recommended in this technical data sheet, the manufacturers must be consulted.

**GENERAL CHARACTERISTICS**

**ELECTRICAL**

**Heater Characteristics**

Heater voltage — preheat . . . . .	5.0 V
Heater current (@ 5.0 volts . . . . .	4.5 — 5.4 A
Minimum preheat time . . . . .	3 minutes

**Typical Operation**

Peak current . . . . .	24 a	Heater voltage operate . . . . .	0.0 V
Current pulse duration . . . . .	2.0 us	VSWR . . . . .	1.5/1 (max.)
Duty cycle . . . . .	.001	Frequency . . . . .	5450-5825 Mc.
Voltage pulse rise time . . . . .	0.1 us min.	Peak anode voltage . . . . .	24.5 kv
Heater voltage start . . . . .	5.0 V	Peak power output . . . . .	300 kw
		Average power output . . . . .	300 W

**MECHANICAL**

Mounting . . . . .	Any
Overall dimensions . . . . .	See drawing
Net weight . . . . .	35 lbs. (approx.)
Tuner torque required . . . . .	30 inch oz. (approx.)
Pressurization . . . . .	30 inch Hg
Output coupling . . . . .	UG 148B/U Choke

**MICROWAVE AND POWER TUBE DIVISION  
RAYTHEON COMPANY**

FOUNDRY AVE., WALTHAM 54, MASS.  
from JEDEC release #3471, Oct. 30, 1961



### DETAILED ELECTRICAL INFORMATION

#### HEATER

The cathode must be preheated at  $E_f = 5.0$  volts for a period of at least three minutes prior to the application of anode high voltage. Immediately after the application of anode high voltage, the heater voltage should be reduced to 0.0 volts. For combinations of pulse widths and duty cycles other than those shown under typical operation, the manufacturer should be consulted for optimum heater schedules. Provisions must be made to keep heater current surges below 30 amps. Surges in excess of 30 amps may open circuit the heater. The cathode preheat schedule must be repeated in case of any interruption in the operation of the tube.

#### PULSE CHARACTERISTICS

The smooth peak is defined as the value of a smooth curve through the average of the fluctuations over the top portion of the pulse. The pulse width is the time interval between the two points on the current pulse at which instantaneous current is 50 percent of the smooth peak. The rise time is the time interval between points of 20 and 85 percent of the smooth peak. Figure 1 shows graphically the definitions mentioned.

The voltage rise time must not be less than .10 usec for a .4 usec pulse to realize good tube performance. Too fast a rise time will lead to moding or arcing. It is necessary to form the pulse so that the current pulse shows no sign of jitter and no large spikes on the leading edge as these conditions also may cause moding or arcing. The ripple on the top of the current pulse must be kept at a minimum to avoid pushing effects which will tend to widen the spectrum. Excessive backswing in the voltage pulse may cause post pulse noise. The backswing should in no case exceed 20% of the applied pulse.

Many magnetrons draw a certain amount of leakage or diode current at anode voltages as low as 100 volts. For this reason it is not only advisable to keep the time duration of the voltage pulse trailing edge as short as possible; but also to prevent the positive voltage backswing from be-

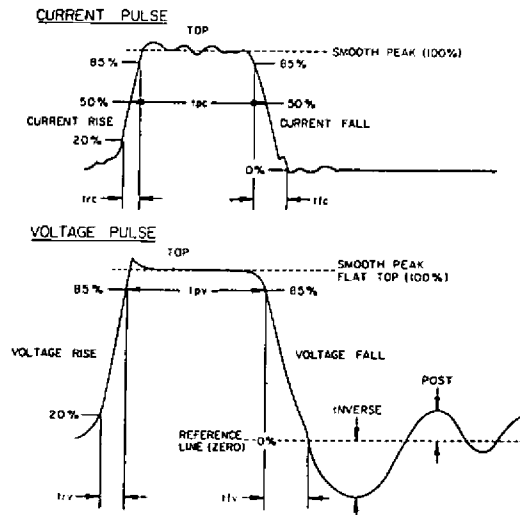

FIG. 1

coming negative again. This diode current can amount to several milliamperes at an average current of 30 milliamperes. Except for giving a false indication as to the actual peak current at which the magnetron is operating, diode current is not harmful unless it becomes excessive.

For optimum pulse shaping, the magnetron, pulse transformer, and pulse line must be treated as a unit. It is advisable to hand tailor an experimental pulse line with careful observation of the current and voltage pulse shapes before a system is placed in production.

It is impossible to design a pulse transformer to give optimum results on both long and short pulses. It is, therefore, necessary to decide which pulse is the more important and to optimize the pulse transformer for the more important operation.

#### OPERATION

The operating characteristics of an average RK-7156 are described in the following paragraphs and illustrated in Figures 2, 3. All measurements were made under conditions of typical performance. Slight variations of these characteristics may be expected from tube to tube, or from use of the same tube in different systems. A 1 x 2 inch waveguide was used for all tests involving a magnetron load.

MICROWAVE AND POWER TUBE DIVISION

RAYTHEON COMPANY

FOUNDRY AVE., WALTHAM 54, MASS.



TUNABLE PULSED-TYPE MAGNETRON

ANODE POTENTIAL, POWER OUTPUT VS ANODE CURRENT

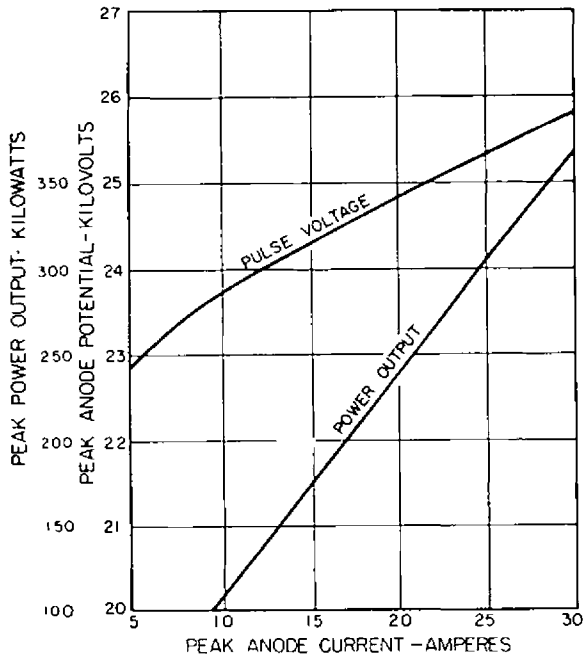

FIG. 2 - PERFORMANCE CHARACTERISTICS OF TYPICAL RK 7156 MAGNETRON 5825 Mc.-1.1/1 VSWR

ANODE POTENTIAL, POWER OUTPUT VS ANODE CURRENT

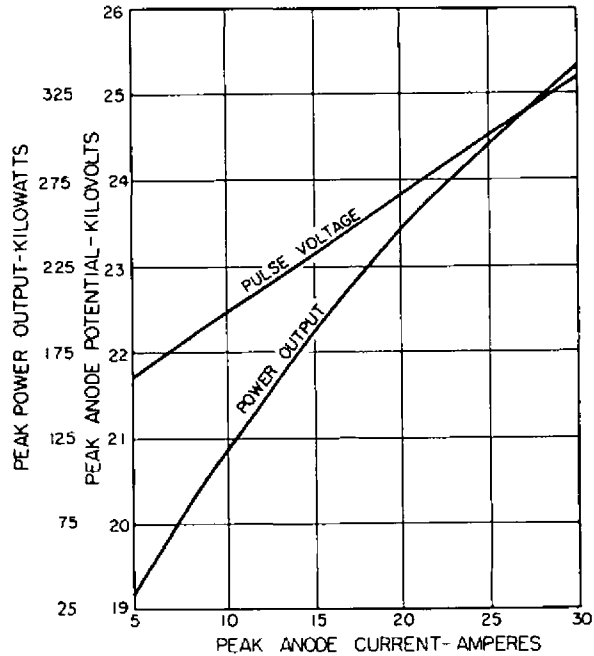
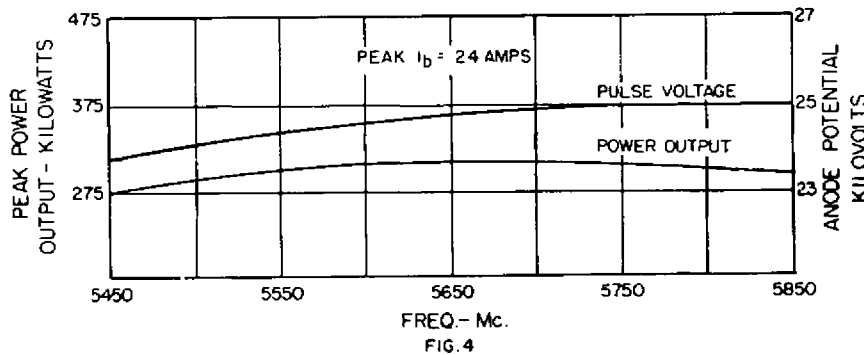

FIG. 3 - PERFORMANCE CHARACTERISTICS OF TYPICAL RK 7156 MAGNETRON 5450 Mc.-1.1/1 VSWR

FREQ. CHARACTERISTICS



FREQUENCY CHARACTERISTICS

The manner in which anode voltage and power output vary with frequency is shown in Figure 4.

LOAD DIAGRAMS

Figure 5 is a load diagram of a typical RK-7156 magnetron indicating the position of the sink re-

gion for frequencies of 5500, 5700 and 5800 megacycles. The contours of constant power output and frequency change are related to voltage standing wave ratios introduced by mismatched loads at various phase positions. Values of VSWR as high as 3.0/1 are plotted, but ratios greater than 1.5/1 are not recommended in systems operation.

MICROWAVE AND POWER TUBE DIVISION

RAYTHEON COMPANY

FOUNDRY AVE., WALTHAM 54, MASS.



### FREQUENCY DRIFT CHARACTERISTICS

After operation of the RK-7156 is initiated, its temperature rises with time until thermal equilibrium is reached. During this transient period the geometry of the tube changes slightly and is attended by a slight frequency change or drift. Frequency drift and anode temperature are plotted as a function of time in Figure 6.

If the tube temperature is changed after thermal equilibrium has been established, the operating frequency will also change until thermal equilibrium is again attained and tube geometry stabilized.

### LOAD AND LINE LENGTH CONSIDERATIONS

Operation of the RK-7156 into a line exceeding a critical length and terminated in an impedance different from the line gives rise to undesirable phenomena collectively termed long line effects. Tuner curve discontinuities and spectrum broadening are samples of the associated results. Figure 7 shows the line length and VSWR recommended for use with the RK-7156. Although the curves apply specifically to an operating frequency of 5650 Mc, they do not change signifi-

cantly at other frequencies in the tuning range. The critical conditions of frequency skip, where breaks in the tuning curve first appear depend somewhat on the pulling figure of individual tubes. Operation within the recommended region indicated on the figure will yield satisfactory operation of all RK-7156 magnetrons. An extensive treatment of long line effects is beyond the scope of this publication. Additional information may be obtained on request from the Applications Engineering Dept., Microwave & Power Tube Operations, Raytheon Mfg. Company.

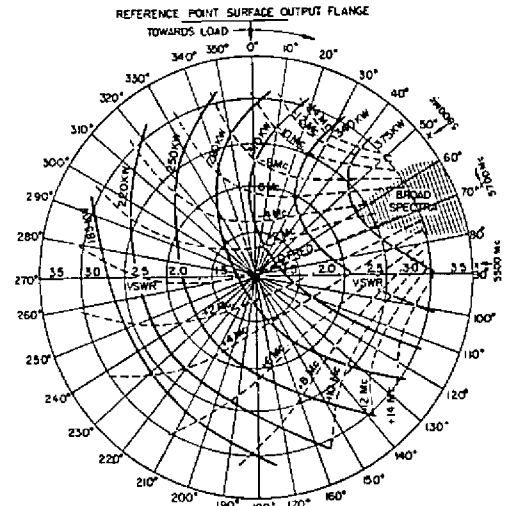

FIG 5 - LOAD DIAGRAM OF TYPICAL RK 7156 MAGNETRON - 5700 Mc

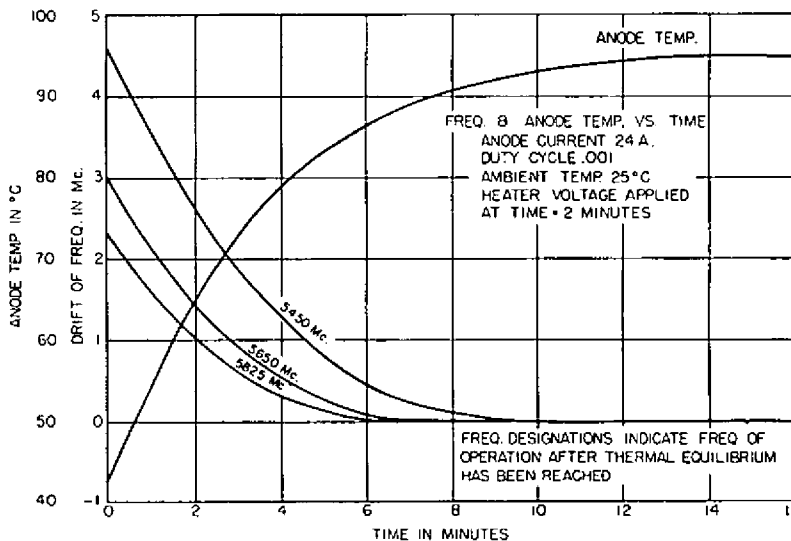

FIG 6 - FREQ DRIFT CHARACTERISTICS FROM COLD START OF TYPICAL RK 7156 MAGNETRON

MICROWAVE AND POWER TUBE DIVISION

RAYTHEON COMPANY

FOUNDRY AVE., WALTHAM 54, MASS.



TUNABLE PULSED-TYPE MAGNETRON

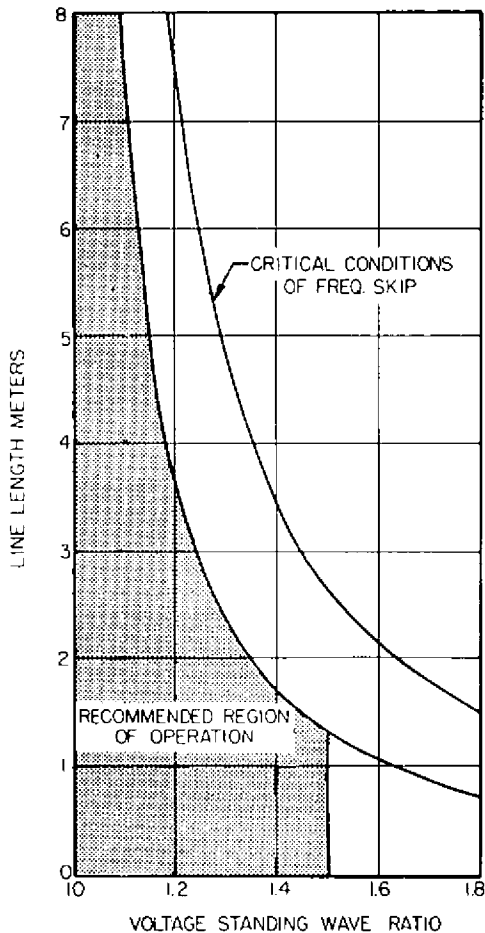

FIG 7- RK 7156 LOAD & LINE LENGTH CONSIDERATIONS 1"x2" WAVE GUIDE

COOLING

The cooling air stream for the RK-7156 should be directed to the air inlet of the radiator through a close fitting duct. Operating anode temperatures below 90°C are recommended although temperatures as high as 120°C can be tolerated.

Figure 8 shows the relationship between air flow (ft<sup>3</sup>/min.) and back pressure (inches H<sub>2</sub>O). Figure 9 shows anode temperature as a function of rate of air flow over the radiator at four values of power input. Tests were made at 30 in. Hg and an ambient temperature of 25°C. Higher ambient

temperatures will result in correspondingly higher anode temperatures.

Use of a close fitting duct can be avoided if a compensating increase in rate of air flow is made.

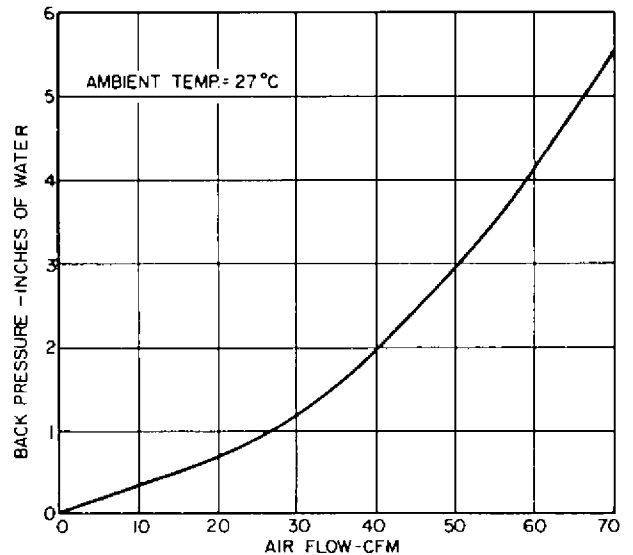

FIG. 8 - COOLING FIN CHARACTERISTICS OF TYPICAL RK7156 MAGNETRON

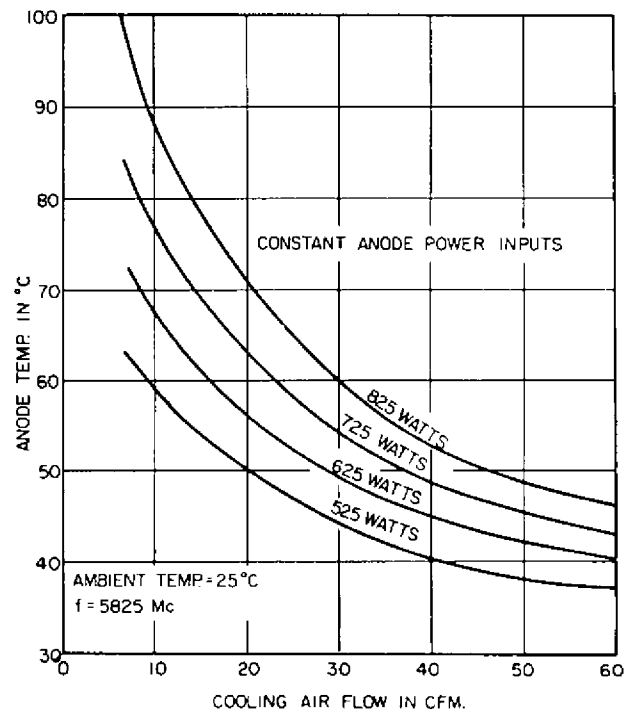

FIG. 9 - COOLING CHARACTERISTICS OF TYPICAL RK 7156 MAGNETRON

MICROWAVE AND POWER TUBE DIVISION

RAYTHEON COMPANY

FOUNDRY AVE., WALTHAM 54, MASS.



## DETAILED MECHANICAL INFORMATION

### OUTLINE DRAWING

The detailed mechanical dimensions are given in Figure 11. These dimensions should be used in designing a mechanical layout for an equipment rather than the dimensions of a sample tube.

### INSTALLATION & HANDLING PRECAUTIONS

The high voltage bushing and output window are protected by guard covers during shipment. These covers must be removed before the tube is installed in its associated equipment. The bushing or output window must not be subjected to any mechanical strain in the handling or mounting of the magnetron.

Care should be taken to keep magnetic material at least 12 inches away from the magnets, since deterioration of the magnetic field results in low power and instability.

Unnecessary jarring of the tube must be avoided. Although a packaged instrument lends the appearance of great structural strength, it is in reality quite fragile. The shocks of careless handling may easily exceed the maximum allowable shock rating.

### MOUNTING

The tube is mounted within the equipment by four  $\frac{1}{4}$  inch bolts passed through the four clearance holes of the mounting plate. The tube may be mounted with the longitudinal axis of the cathode high voltage bushing in any position.

### ELECTRICAL CONNECTIONS

Electrical input connections are made to the frame of the tube and to two flexible leads terminated in lugs with clearance holes for #10-32 screws. Positive high voltage is grounded to the frame, preferably the mounting plate. Both flexible leads project radially from the cathode high voltage bushing. The lead at the extreme end of the bush-

ing is connected to the heater power supply; the other, identified by a brown band, serves as a common lead for the remaining heater connection and the negative high voltage cathode terminal.

### COUPLING & PRESSURIZATION

The load should be attached to the RK-7156 output system through standard 1 x 2 inch waveguide equipped with a type UG148B/U choke flange. The eight tapped holes of the choke flange should be drilled to provide clearance for #10-32 screws. The output section of the magnetron should not be used to support either the weight of the tube or that of the load.

The RK-7156 magnetron is intended for operation at the barometric pressure common at sea level. Electrical breakdown across the cathode high voltage bushing may occur at appreciably lower pressures. If sustained arcing in the waveguide occurs, it will generally move along the guide towards the output window of the tube, and may result in failure of the window. To minimize the possibility of arcing in the guide, and to achieve optimum tube performance, the VSWR in the guide should be kept as low as possible; VSWR values greater than 1.5/1 are not recommended.

### TUNER CHARACTERISTICS

Approximately 13 turns of the tuner spline, at an applied torque of  $1\frac{1}{2}$  inch lbs., are required to tune the RK-7156 through its frequency range. Internal mechanical tuner stops designed to withstand a torque of 200 inch ounces allow a slightly wider tuning range than specified, but operation out of the specified band is not recommended. See Figure 10.

Further information on the operation and capabilities of this and other type magnetrons may be obtained on request from the Applications Engineering Department, Microwave & Power Tube Operations, Raytheon Manufacturing Company, Waltham, Mass.

MICROWAVE AND POWER TUBE DIVISION

RAYTHEON COMPANY

FOUNDRY AVE., WALTHAM 54, MASS.



# TUNABLE PULSED-TYPE MAGNETRON

## TYPE RK-7156

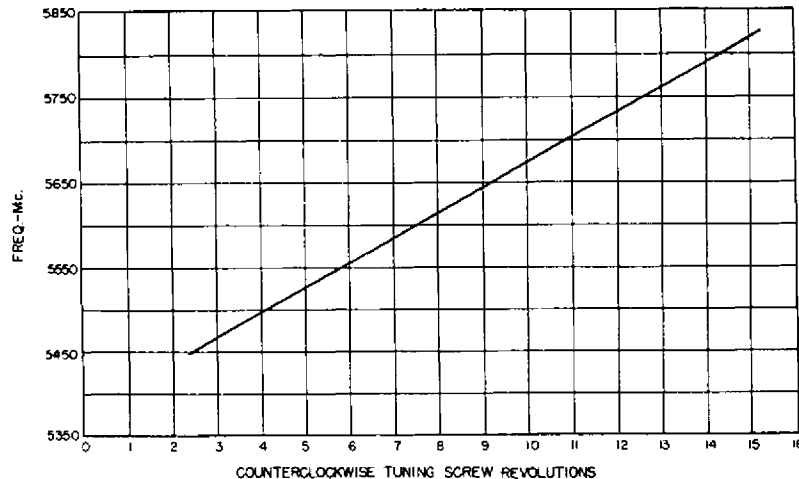

COUNTERCLOCKWISE TUNING SCREW REVOLUTIONS  
 FIG. 10-TUNING CHARACTERISTICS OF TYPICAL RK 7156 MAGNETRON

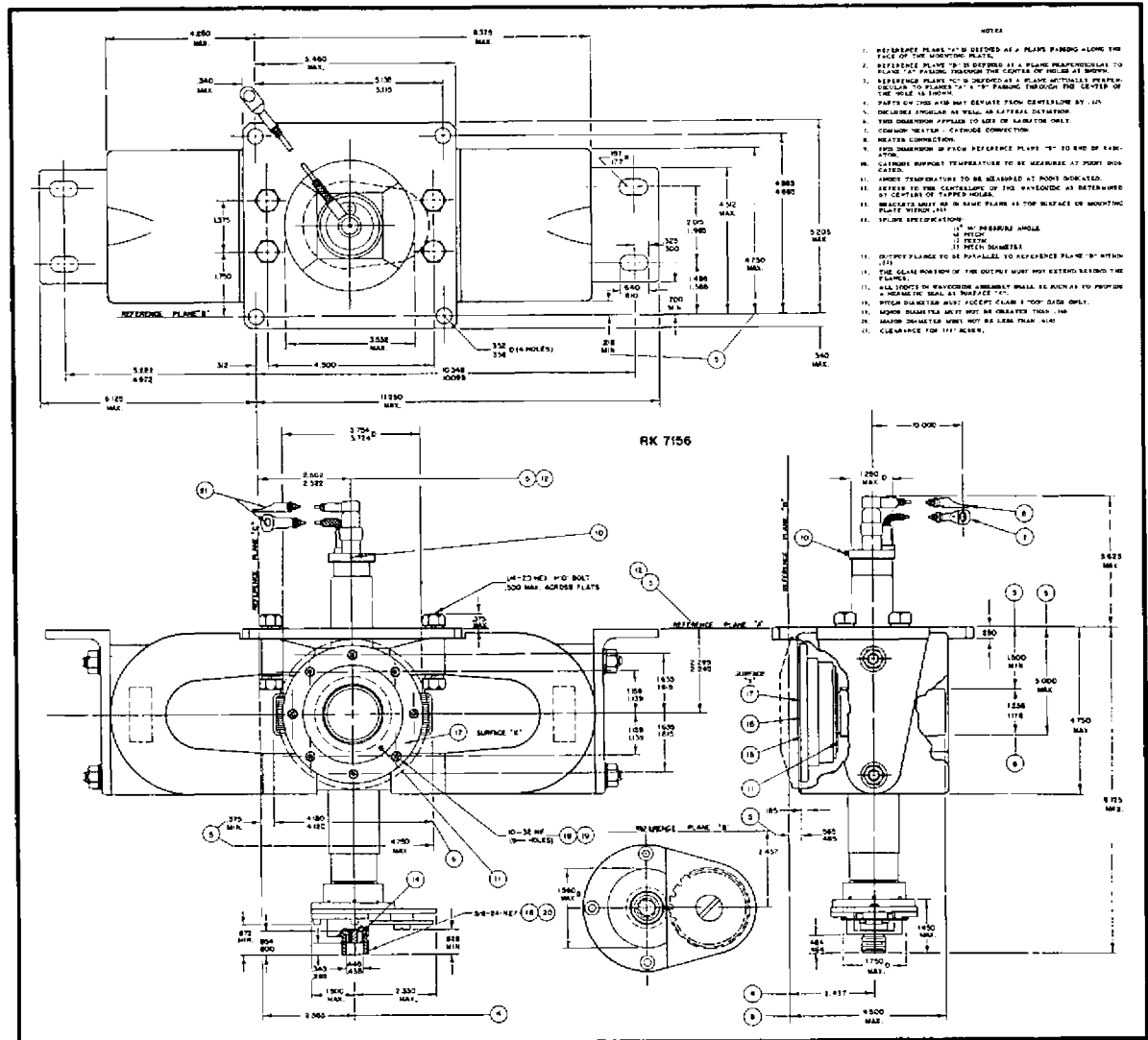

MICROWAVE AND POWER TUBE DIVISION

# RAYTHEON COMPANY

FOUNDRY AVE., WALTHAM 54, MASS.